

# CHAMBERLAIN®

## Chain Drive Garage Door Opener

Models HD220, HD220C,  
PD220, PD222, and LW260C

FOR RESIDENTIAL USE ONLY

INSTALL ON 7 FOOT  
SECTIONAL DOORS ONLY

Register your new garage door opener at  
[www.prodregister.com/chamberlain](http://www.prodregister.com/chamberlain) or  
scan the QR code with your smartphone

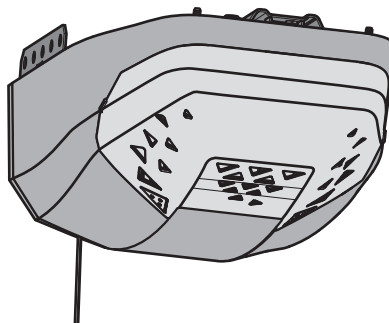

- Please read this manual and the enclosed safety materials carefully!
- Fasten the manual near the garage door after installation.
- The door **WILL NOT CLOSE** unless the Protector System® is connected and properly aligned.
- Periodic checks of the garage door opener are required to ensure safe operation.
- The model number label is located on the back panel of your garage door opener.
- This garage door opener is compatible with Security+ 2.0™ accessories.
- **WARNING:** To reduce the risk of injury to persons – Use this opener **ONLY** with a 7 foot sectional door.

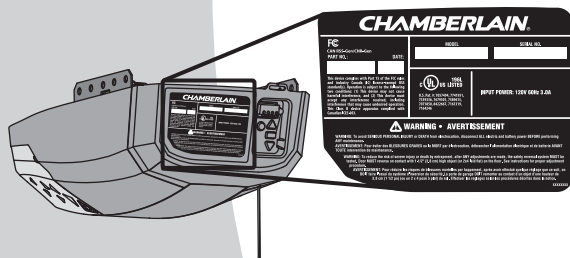

Write down the following information  
for future reference:

Model Number:

Serial Number:

Date of Purchase:

## CONTENTS

Preparation .....	1-4
Assembly .....	5-9
Installation .....	10-17
Install the Door Control .....	18-19
Install the Protector System® .....	20-23
Power .....	24-25
Adjustments .....	26-28
Operation .....	29
Features .....	30
Remote Control .....	31
To Erase the Memory .....	32
To Open the Door Manually .....	32
Maintenance .....	33
Diagnostic Chart .....	34
Warranty .....	35



[www.chamberlain.com](http://www.chamberlain.com)

The Chamberlain Group, Inc.  
845 Larch Avenue  
Elmhurst, Illinois 60126-1196

# Preparation

## Safety Symbol and Signal Word Review

This garage door opener has been designed and tested to offer safe service provided it is installed, operated, maintained and tested in strict accordance with the instructions and warnings contained in this manual.

When you see these Safety Symbols and Signal Words on the following pages, they will alert you to the possibility of **serious injury or death** if you do not comply with the warnings that accompany them. The hazard may come from something mechanical or from electric shock. Read the warnings carefully.

 **WARNING**

**Mechanical**

 **WARNING**

**Electrical**

When you see this Signal Word on the following pages, it will alert you to the possibility of damage to your garage door and/or the garage door opener if you do not comply with the cautionary statements that accompany it. Read them carefully.

**CAUTION**

## Check the Door

 **WARNING**

To prevent possible SERIOUS INJURY or DEATH:

- ALWAYS call a trained door systems technician if garage door binds, sticks, or is out of balance. An unbalanced garage door may NOT reverse when required.
- NEVER try to loosen, move or adjust garage door, door springs, cables, pulleys, brackets or their hardware, ALL of which are under EXTREME tension.
- Disable ALL locks and remove ALL ropes connected to garage door BEFORE installation and operating garage door opener to avoid entanglement.

**CAUTION**

To prevent damage to garage door and opener:

- ALWAYS disable locks BEFORE installing and operating the opener.
- ONLY operate garage door opener at 120 V, 60 Hz to avoid malfunction and damage.

1. Disable locks and remove any ropes connected to the garage door.
2. Lift the door halfway up. Release the door. If balanced, it should stay in place, supported entirely by its springs.
3. Raise and lower the door to check for binding or sticking. If your door binds, sticks, or is out of balance, call a trained door systems technician.
4. Check the seal on the bottom of the door. Any gap between the floor and the bottom of the door must not exceed 1/4 inch (6 mm). Otherwise, the safety reversal system may not work properly.
5. The opener should be installed above the center of the door. If there is a torsion spring or center bearing plate in the way of the header bracket, it may be installed within 4 feet (1.2 m) to the left or right of the door center. See page 11.

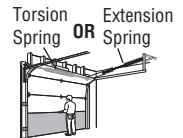

# Preparation

## Additional Items You May Need:

Survey your garage area to see if you will need any of the following items:

- **(2) 2X4 PIECES OF WOOD**

May be used to fasten the header bracket to the structural supports. Also used to position the garage door opener during installation and for testing the safety reversing sensors.

- **SUPPORT BRACKET AND FASTENING HARDWARE**

Must be used if you have a finished ceiling in your garage.

- **EXTENSION BRACKETS (MODEL 041A5821-1) OR WOOD BLOCKS**

Depending upon garage construction, extension brackets or wood blocks may be needed to install the safety reversing sensor.

- **FASTENING HARDWARE**

Alternate floor mounting of the safety reversing sensor will require hardware not provided.

- **OUTSIDE QUICK RELEASE (MODEL 7702CB OR MODEL 7702C)**

Required for a garage with NO access door.

- **DOOR REINFORCEMENT**

Required if you have a lightweight steel, aluminum, fiberglass or glass panel door.

## Tools Needed

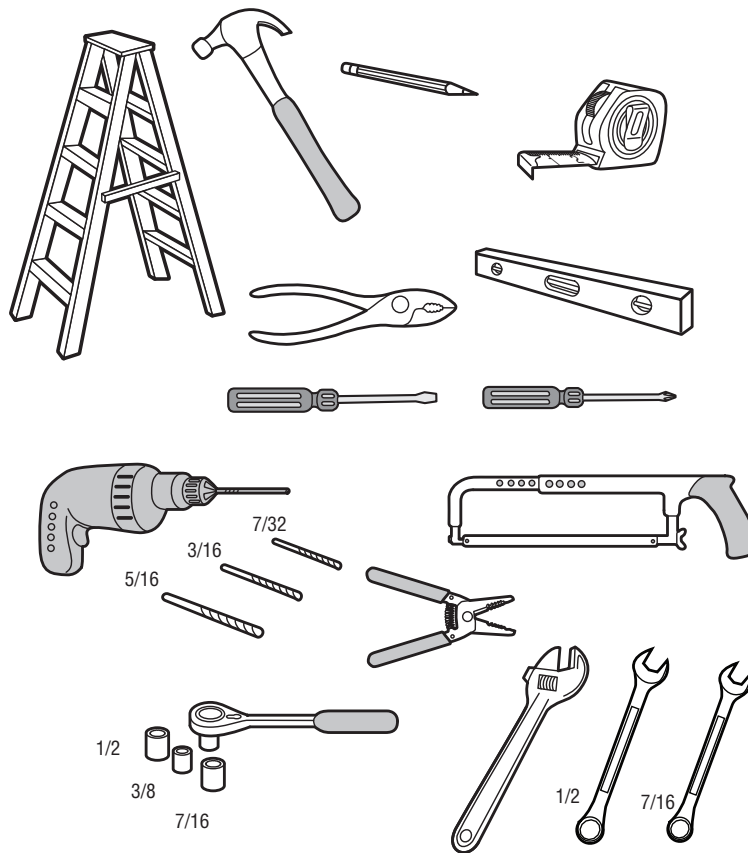

# Preparation

## Carton Inventory/Repair Parts

Your garage door opener is packaged in one carton which contains the motor unit and all parts illustrated below. Accessories vary depending on the garage door opener model purchased. Depending on your model, other accessories may be included with your garage door opener. Instructions for these accessories will be attached to the accessory and are not included in this manual. Save the carton and packing material until the installation and adjustment is complete. The images throughout this manual are for reference only and your product may look different.

Key	Description	Part #
A	Header bracket	41A5047-1
B	Pulley (In hardware bag)	
C	Door bracket	41A5047
D	Curved door arm	
E	Straight door arm (Packaged inside front rail section)	
F	Trolley <b>NOTE: Be sure to assemble the trolley before sliding onto rail.</b>	41C5141-1
G	Emergency release rope and handle (In hardware bag)	
H	Rail (1 front and 4 center sections)	
I	Hanging brackets (2) (Packaged inside the front rail section)	
J	Garage door opener (motor unit)	
K	Chain spreader (In hardware bag)	
L	Chain and cable	
M	Door control	041A7367-3
N	Remote control	950ESTD
O	<b>The Protector System</b> <sup>®</sup> Safety reversing sensors with 2 conductor white and white/black wire attached: Sending Sensor (1), Receiving Sensor (1)	41A5034
P	Safety Sensor Brackets (2)	041A5266-1
<b>NOT SHOWN</b>		
	White and red/white wire	41B4494-1
	Owner's manual	114A4706
	Hardware	

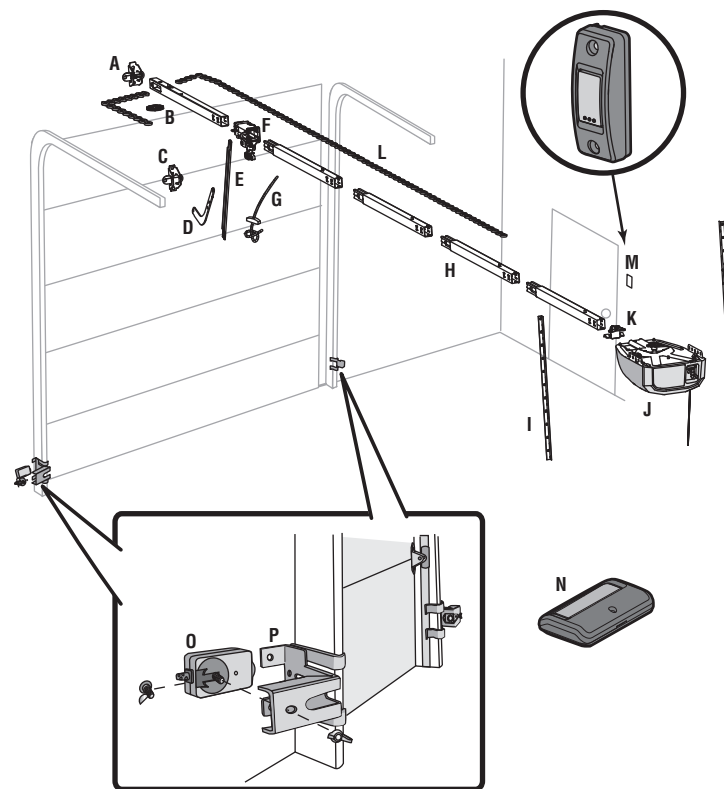

# Preparation

## Hardware 041A8068

### ASSEMBLY

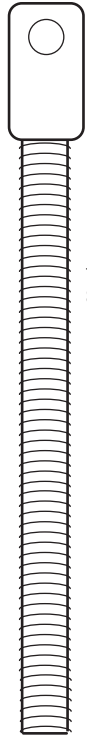

Threaded Shaft

Self-Threading Screw  
1/4"-20x1-3/4" (2)

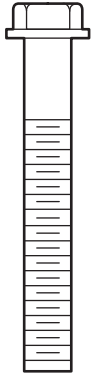

Clevis Pin  
5/16"x1-1/2"

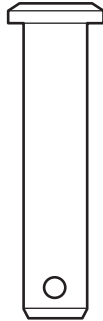

Master Link

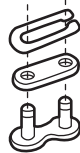

### INSTALLATION

Lag Screw 5/16"-9x1-5/8" (2)

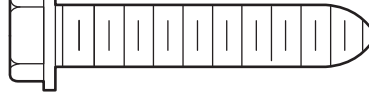

Lag Screw #14-10x1-1/2" (2)

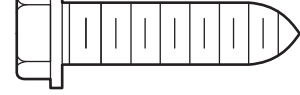

Clevis Pin 5/16"x1-1/2"

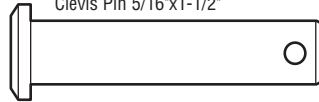

Clevis Pin 5/16"x1-1/4"

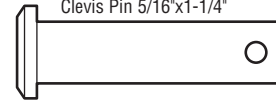

Clevis Pin 5/16"x1"

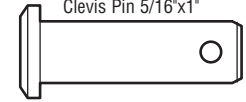

Carriage Bolt  
1/4"-20x1/2" (2)

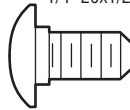

Hex Nuts 5/16" (2)



Self-Threading Screw  
1/4"-14x5/8" (2)

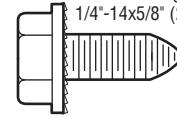

Hex Bolt 1/4"-20x3/4" (4)

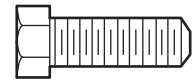

Lock Nut 1/4"-20 (4)

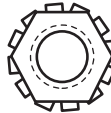

Lock Washer 5/16"



Wing Nut 1/4"-20 (2)

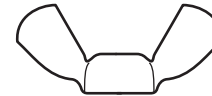

Ring Fastener (4)



### DOOR CONTROL



Screw 6ABx1" (2)

# Assembly

## STEP 1 Assemble the rail and trolley

### CAUTION

To prevent INJURY from pinching, keep hands and fingers away from the joints while assembling the rail.

To avoid installation difficulties, do not run the garage door opener until instructed to do so.

The front rail has a cut out "window" at the door end (see illustration). The front rail has a rail tab. This tab MUST be on the top of the rail when assembled.

1. Remove the straight door arm and hanging bracket packaged inside the front rail and set aside for Installation Step 5 and 9. **NOTE:** To prevent INJURY while unpacking the rail carefully remove the straight door arm stored within the rail section.
2. The rail sections have a groove on the sides near the bottom edge. Use these grooves to align the rail sections. Slide the tapered ends into the larger ones. Tabs along the side will lock into place.
3. As a temporary stop, insert a screwdriver into the hole in the second rail section from the motor unit, as shown.
4. Check to be sure there are 4 plastic wear pads inside the inner trolley. If they became loose during shipping, check all packing material. Snap them back into position as shown.
5. Slide the trolley assembly toward the screwdriver as shown.
6. Slide the chain spreader onto the rail until it stops.

**TIP:** Ensure the rail sections are aligned properly and the chain spreader has been installed before fastening the rail to motor unit.

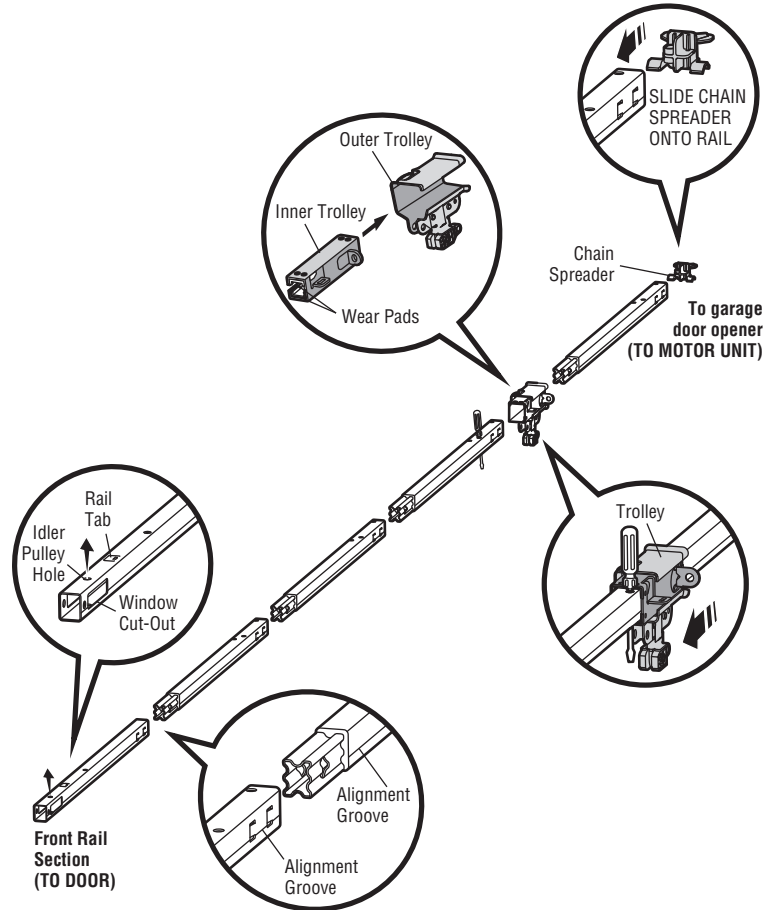

# Assembly

## STEP 2 Fasten the rail to the motor unit

### CAUTION

To avoid SERIOUS damage to garage door opener, use ONLY the 1/4"-20x1-3/4" self-threading screws provided.

1. Place the motor unit on packing material to protect the cover, and rest the back end of the rail on top. For convenience, put a support under the front end of the rail.
2. Ensure that the chain spreader is installed.
3. Place the rail onto the motor unit. Align the screw holes in the rail with the holes on top of the motor unit.
4. Use a 1/4" socket to fasten the rail with the screws; DO NOT use any power tools. The use of power tools may permanently damage the garage door opener.

#### HARDWARE

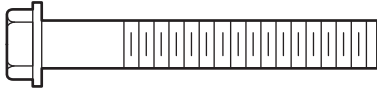

Self-Threading Screw  
1/4"-20x1-3/4"

**IMPORTANT:** Use ONLY the 1/4"-20x1-3/4" self-threading screws provided in a separate bag inside the hardware bag.

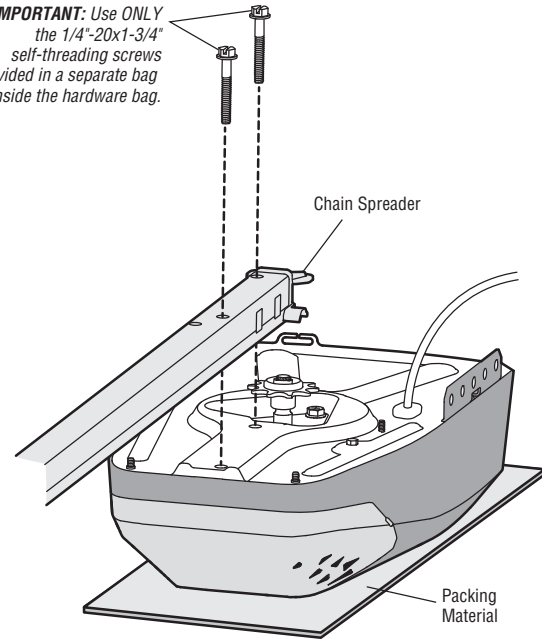

# Assembly

## STEP 3 Install the pulley

1. Lay the chain/cable beside the rail, as shown. Grasp the end with the cable loop and pass approximately 12" (30 cm) of cable through the window. Allow it to hang until Assembly Step 4.
2. Remove the tape from the idler pulley. The inside center should be pre-greased. If dry, regrease to ensure proper operation.
3. Place the idler pulley into the window as shown.
4. Secure idler pulley with clevis pin and ring fastener.
5. Rotate the pulley to be sure it spins freely.
6. Locate the rail tab. The rail tab is near the idler pulley on the front rail section. Use a flat head screwdriver and lift the rail tab until the tab is vertical (90°).

### HARDWARE

Clevis Pin 5/16"x1-1/2"

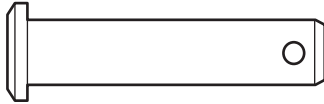

Ring Fastener

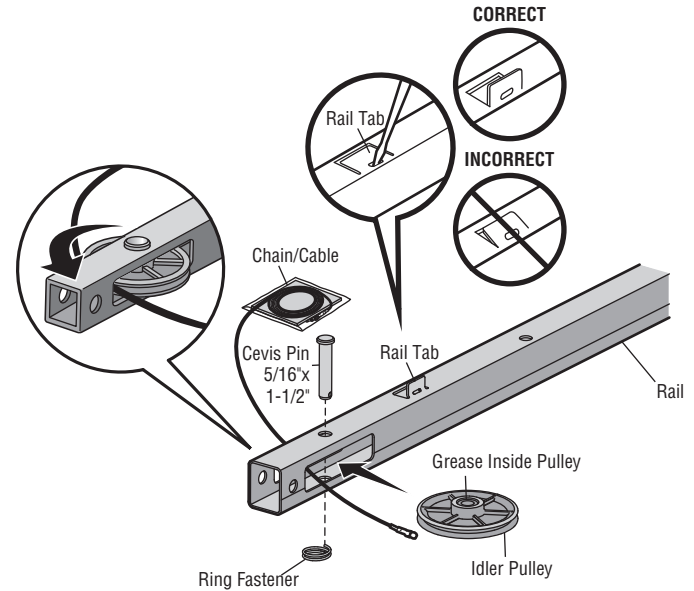



# Assembly

## STEP 4 Install the chain

### WARNING

To avoid possible SERIOUS INJURY to finger from moving garage door opener:

- ALWAYS keep hand clear of sprocket while operating opener.
- Securely attach chain spreader BEFORE operating.

1. Pull the cable around the idler pulley and toward the trolley.
2. Connect the cable to the retaining slot on the trolley. (Figure 1)
  - a. Push pins of master link bar through cable link and trolley slot.
  - b. Push master link cap over pins and past pin notches.
  - c. Slide the closed end of the clip-on spring over one of the pins. Push the open end of the clip-on spring onto the other pin.
3. With the trolley against the screwdriver, dispense the remainder of the cable/chain along the rail toward the motor unit into the slot on the chain spreader, around the sprocket onto the chain spreader and continuing to the trolley assembly. The sprocket teeth must engage the chain. (Figure 2)
4. Check to make sure the chain is not twisted, then connect it to the threaded shaft with the remaining master link.
5. Thread the inner nut and lock washer onto the trolley thread shaft
6. Insert the trolley threaded shaft through the hole in the trolley. Be sure the chain is not twisted. (Figure 3)
7. Loosely thread the outer nut onto the trolley threaded shaft.
8. Remove the screwdriver.

### HARDWARE

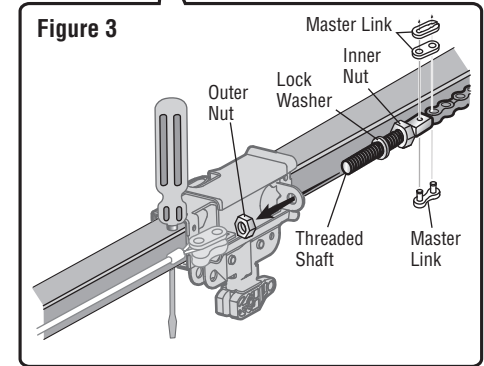
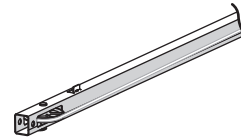
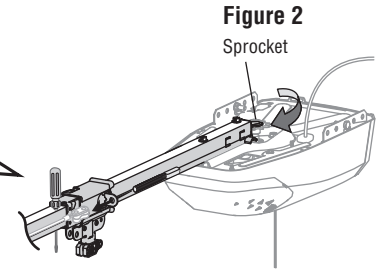
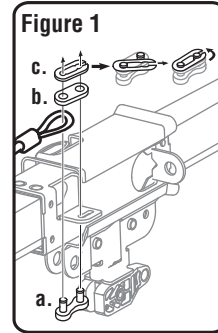
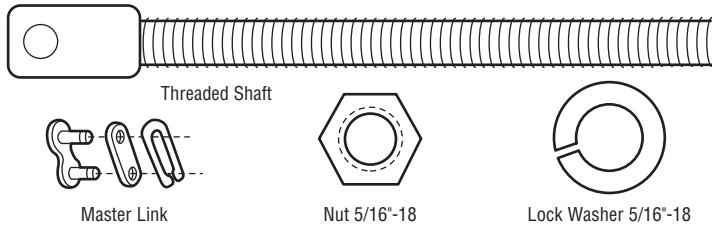

# Assembly

## STEP 5 Tighten the chain

1. Spin the inner nut and lock washer down the trolley threaded shaft, away from the trolley.
2. To tighten the chain, turn the outer nut in the direction shown.
3. When the chain is approximately 1/4" (6 mm) above the base of the rail at its midpoint, re-tighten the inner nut to secure the adjustment.

Sprocket noise can result if the chain is too loose or too tight. When installation is complete, you may notice some chain droop with the door closed. This is normal. If the chain returns to the position shown when the door is open, do not re-adjust the chain.

**NOTES:** During future maintenance, ALWAYS pull the emergency release handle to disconnect the trolley before adjusting the chain.

**You have now finished assembling your garage door opener. Please read the following warnings before proceeding to the installation section.**

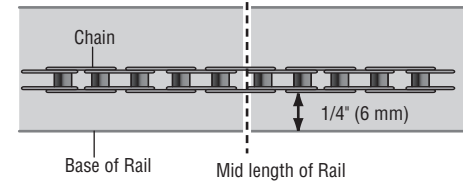
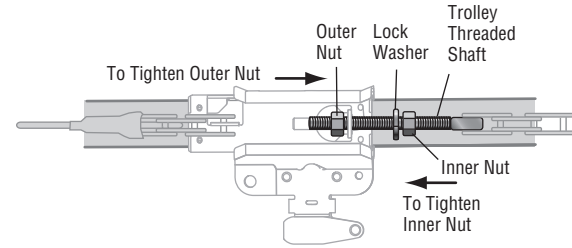

## IMPORTANT INSTALLATION INSTRUCTIONS

### **WARNING**

### To reduce the risk of **SEVERE INJURY** or **DEATH**:

1. READ AND FOLLOW ALL INSTALLATION WARNINGS AND INSTRUCTIONS.
2. Install garage door opener ONLY on properly balanced and lubricated garage door. An improperly balanced door may NOT reverse when required and could result in SEVERE INJURY or DEATH.
3. ALL repairs to cables, spring assemblies and other hardware MUST be made by a trained door systems technician BEFORE installing opener.
4. Disable ALL locks and remove ALL ropes connected to garage door BEFORE installing opener to avoid entanglement.
5. Install garage door opener 7 feet (2.13 m) or more above floor.
6. Mount the emergency release within reach, but at least 6 feet (1.83 m) above the floor and avoiding contact with vehicles to avoid accidental release.
7. NEVER connect garage door opener to power source until instructed to do so.
8. NEVER wear watches, rings or loose clothing while installing or servicing opener. They could be caught in garage door or opener mechanisms.
9. Install wall-mounted garage door control:
  - within sight of the garage door.
  - out of reach of children at minimum height of 5 feet (1.5 m).
  - away from ALL moving parts of the door.
10. Place entrapment warning label on wall next to garage door control.
11. Place manual release/safety reverse test label in plain view on inside of garage door.
12. Upon completion of installation, test safety reversal system. Door MUST reverse on contact with a 1-1/2" (3.8 cm) high object (or a 2x4 laid flat) on the floor.
13. To avoid SERIOUS PERSONAL INJURY or DEATH from electrocution, disconnect ALL electric power BEFORE performing ANY service or maintenance.

# Installation

## STEP 1 Determine the header bracket location

### WARNING

To prevent possible SERIOUS INJURY or DEATH:

- Header bracket **MUST** be RIGIDLY fastened to structural support on header wall or ceiling, otherwise garage door might **NOT** reverse when required. **DO NOT** install header bracket over drywall.
- Concrete anchors **MUST** be used if mounting header bracket or 2x4 into masonry.
- **NEVER** try to loosen, move or adjust garage door, springs, cables, pulleys, brackets, or their hardware, **ALL** of which are under **EXTREME** tension.
- **ALWAYS** call a trained door systems technician if garage door binds, sticks, or is out of balance. An unbalanced garage door might **NOT** reverse when required.

1. Close the door and mark the inside vertical centerline of the garage door.
2. Extend the line onto the header wall above the door.

You can fasten the header bracket within 4 feet (1.22 m) of the left or right of the door center only if a torsion spring or center bearing plate is in the way; or you can attach it to the ceiling when clearance is minimal. (It may be mounted on the wall upside down if necessary, to gain approximately 1/2" (1 cm).

If you need to install the header bracket on a 2x4 (on wall or ceiling), use lag screws (not provided) to securely fasten the 2x4 to structural supports.

3. Open your door to the highest point of travel as shown. Draw an intersecting horizontal line on the header wall 2" (5 cm) above the high point.

**NOTE:** If the total number of inches exceeds the height available in your garage, use the maximum height possible, or refer to page 12 for ceiling installation.

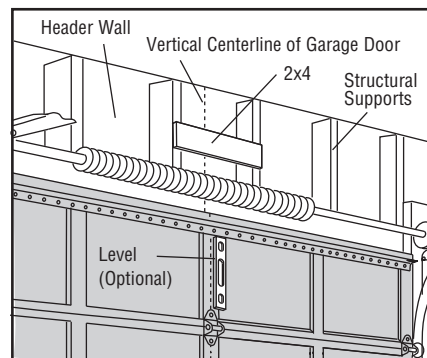

### OPTIONAL CEILING MOUNT FOR HEADER BRACKET

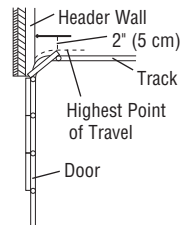
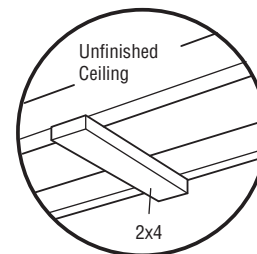

Sectional door with curved track

# Installation

## STEP 2 Install the header bracket

You can attach the header bracket either to the wall above the garage door, or to the ceiling. Follow the instructions which will work best for your particular requirements. Do not install the header bracket over drywall. If installing into masonry, use concrete anchors (not provided).

### HARDWARE

Lag Screw 5/16"-9x1-5/8"

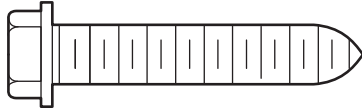

## OPTION A WALL INSTALLATION

1. Center the bracket on the vertical centerline with the bottom edge of the bracket on the horizontal line as shown (with the arrow pointing toward the ceiling).
2. Mark the vertical set of bracket holes. Drill 3/16" pilot holes and fasten the bracket securely to a structural support with the hardware provided.

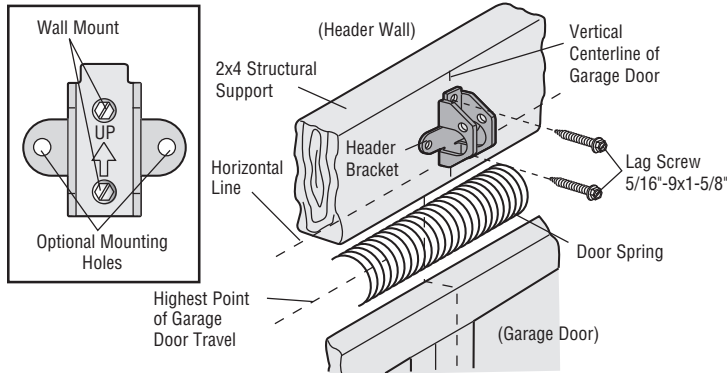

## OPTION B CEILING INSTALLATION

1. Extend the vertical centerline onto the ceiling as shown.
2. Center the bracket on the vertical mark, no more than 6" (15 cm) from the wall. Make sure the arrow is pointing away from the wall. The bracket can be mounted flush against the ceiling when clearance is minimal.
3. Mark the side holes. Drill 3/16" pilot holes and fasten bracket securely to a structural support with the hardware provided.

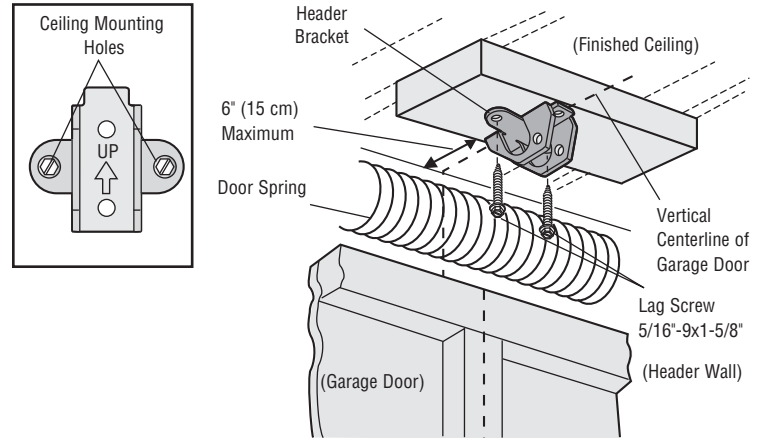

# Installation

## STEP 3 Attach the rail to the header bracket

1. Align the rail with the header bracket. Insert the clevis pin through the holes in the header bracket and rail. Secure with the ring fastener.

**NOTE:** Use the packing material as a protective base for the garage door opener.

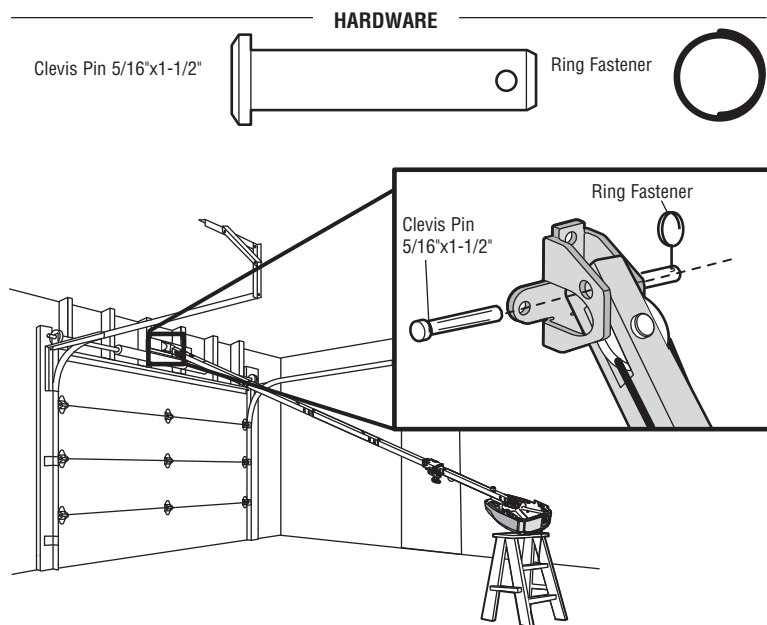

## STEP 4 Position the garage door opener

### CAUTION

To prevent damage to garage door, rest garage door opener rail on 2x4 placed on top section of door.

1. Remove the packing material and lift the garage door opener onto a ladder.
2. Fully open the door and place a 2x4 (laid flat) under the rail.

**NOTE:** A 2x4 is ideal for setting the distance between the rail and the door. If the ladder is not tall enough you will need help at this point. If the door hits the trolley when it is raised, pull the trolley release arm down to disconnect the inner and outer trolley. Slide the outer trolley toward the garage door opener. The trolley can remain disconnected until instructed.

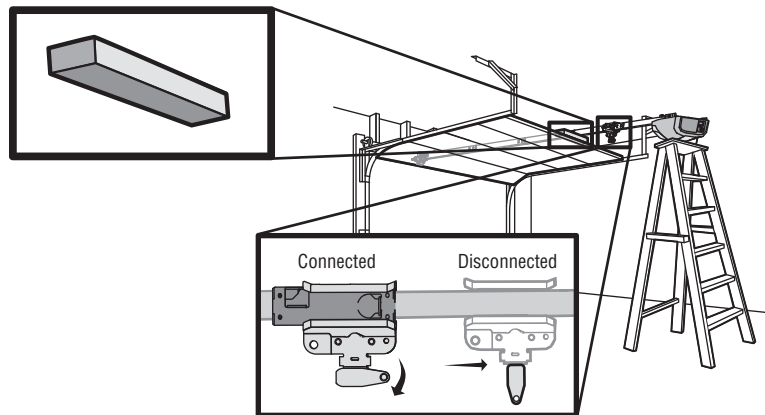

# Installation

## STEP 5 Hang the garage door opener

### **WARNING**

To avoid possible **SERIOUS INJURY** from a falling garage door opener, fasten it **SECURELY** to structural supports of the garage. Concrete anchors **MUST** be used if installing **ANY** brackets into masonry.

Hanging the garage door opener will vary depending on your garage. Below are three example installations. Your installation may be different. For **ALL** installations the garage door opener **MUST** be connected to structural supports. The instructions illustrate one of the examples below.

Finished Ceiling

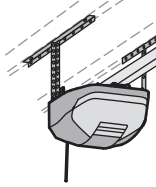

Unfinished Ceiling

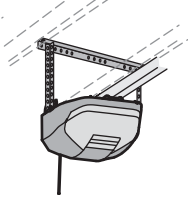

Unfinished Ceiling

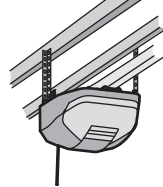

### HARDWARE

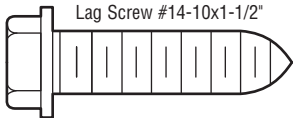

Lag Screw #14-10x1-1/2"

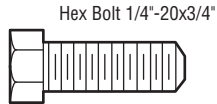

Hex Bolt 1/4"-20x3/4"



Lock Nut 1/4"-20

1. On finished ceilings, use the #14-10x1-1/2" lag screws to attach a support bracket (not provided) to the structural supports before installing the garage door opener.
2. Make sure the garage door opener is aligned with the header bracket. Measure the distance from each side of the garage door opener to the support bracket.
3. Cut both pieces of the hanging bracket to required lengths.
4. Attach the end of each hanging bracket to the support bracket with appropriate hardware (not provided).
5. Attach the garage door opener to the hanging brackets with the hex bolts and nuts.
6. Remove the 2x4 and manually close the door. If the door hits the rail, raise the header bracket.

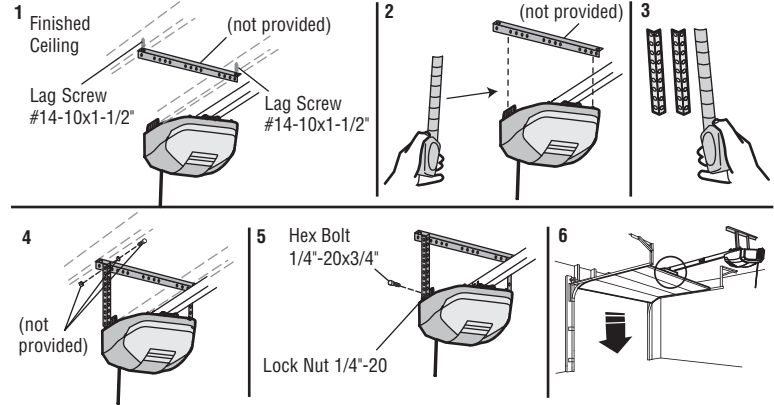

# Installation

## STEP 6 Install the light bulb

### CAUTION

To prevent possible OVERHEATING of the end panel or light socket:

- Use ONLY A19 incandescent (60W maximum) or compact fluorescent (23W maximum) light bulbs.
- DO NOT use incandescent bulbs larger than 60W.

To prevent damage to the opener:

- DO NOT use compact fluorescent light bulbs larger than 23W (100W) equivalent.
- DO NOT use halogen bulbs.
- DO NOT use short neck or specialty light bulbs.

1. Press the triangular release buttons and swing the lens open.
2. Insert an A19 incandescent (60W maximum) or compact fluorescent (23W, 100W equivalent) light bulb into the light socket.
3. Swing the lens shut until triangular buttons click into place.

**NOTE:** Do not use halogen, short neck, or specialty light bulbs as these may overheat the unit. The use of LED bulbs may reduce the operating range or performance of your remote controls.

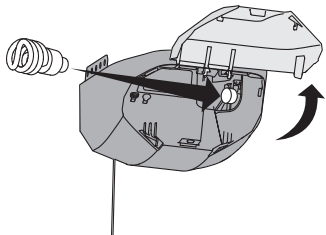

## STEP 7 Attach the emergency release rope and handle

### WARNING

To prevent possible SERIOUS INJURY or DEATH from a falling garage door:

- If possible, use emergency release handle to disengage trolley ONLY when garage door is CLOSED. Weak or broken springs or unbalanced door could result in an open door falling rapidly and/or unexpectedly.
- NEVER use emergency release handle unless garage doorway is clear of persons and obstructions.
- NEVER use handle to pull door open or closed. If rope knot becomes untied, you could fall.

1. Insert one end of the emergency release rope through the handle. Make sure that "NOTICE" is right side up. Tie a knot at least 1 inch (2.5 cm) from the end of the emergency release rope.
2. Insert the other end of the emergency release rope through the hole in the trolley release arm. Mount the emergency release within reach, but at least 6 feet (1.83 m) above floor, avoiding contact with vehicles to prevent accidental release and secure with a knot.

**NOTE:** If it is necessary to cut the emergency release rope, seal the cut end with a match or lighter to prevent unraveling. Ensure the emergency release rope and handle are above the top of all vehicles to avoid entanglement.

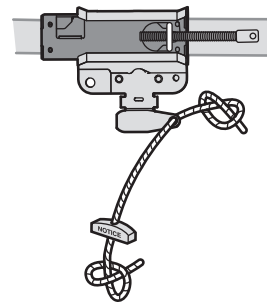



# Installation

## STEP 8 Install the door bracket

### CAUTION

Fiberglass, aluminum or lightweight steel garage doors **WILL REQUIRE** reinforcement BEFORE installation of door bracket. Contact the garage door manufacturer or installing dealer for opener reinforcement instructions or reinforcement kit. Failure to reinforce the top section as required according to the door manufacturer may void the door warranty.

A horizontal and vertical reinforcement is needed for lightweight garage doors (fiberglass, aluminum, steel, doors with glass panel, etc.) (not provided). A horizontal reinforcement brace should be long enough to be secured to two or three vertical supports. A vertical reinforcement brace should cover the height of the top panel. Contact the garage door manufacturer or installing dealer for opener reinforcement instructions or reinforcement kit.

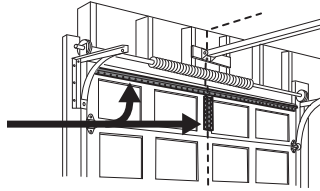

**NOTE:** Many door reinforcement kits provide for direct attachment of the clevis pin and door arm. In this case you will not need the door bracket; proceed to the next step.

#### HARDWARE

Self-Threading Screw  
1/4"-14x5/8"

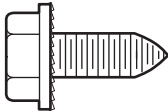

## OPTION A SECTIONAL DOORS

- Center the door bracket on the previously marked vertical centerline used for the header bracket installation. Note correct UP placement, as stamped inside the bracket.
- Position the top edge of the bracket 2"-4" (5-10 cm) below the top edge of the door, OR directly below any structural support across the top of the door.
- Mark, drill holes and install as follows, depending on your door's construction:

**Metal or light weight doors using a vertical angle iron brace between the door panel support and the door bracket:**

- Drill 3/16" fastening holes. Secure the door bracket using the two 1/4"-14x5/8" self threading screws. (Figure 1)
- Alternately, use two 5/16"-18x2" bolts, lock washers and nuts (not provided). (Figure 2)

**Metal, insulated or light weight factory reinforced doors:**

- Drill 3/16" fastening holes. Secure the door bracket using the self-threading screws. (Figure 3)

**Wood Doors:**

- Use top and bottom or side to side door bracket holes. Drill 5/16" holes through the door and secure bracket with 5/16"-18x2" carriage bolts, lock washers and nuts (not provided). (Figure 4)

**NOTE:** The 1/4"-14x5/8" self-threading screws are not intended for use on wood doors.

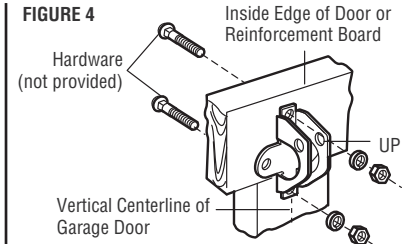
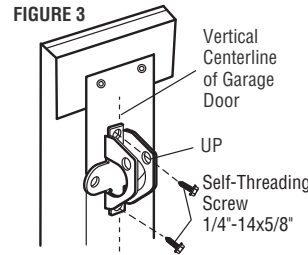
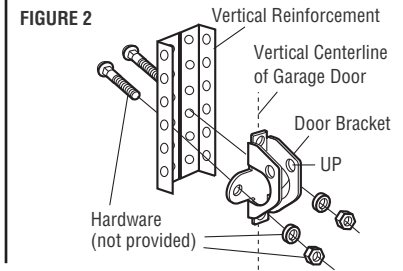
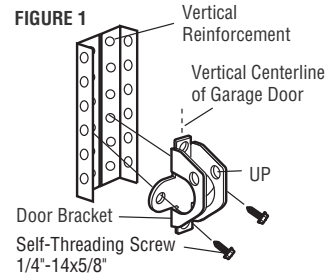

# Installation

## STEP 9 Connect the door arm to the trolley

**IMPORTANT:** The groove on the straight door arm **MUST** face away from the curved door arm.

1. Close the door. Disconnect the trolley by pulling the emergency release handle.
2. Attach the straight door arm to the outer trolley using the clevis pin. Secure with the ring fastener.
3. Attach the curved door arm to the door bracket using the clevis pin. Secure with the ring fastener.
4. Bring arm sections together. Find two pairs of holes that line up and join sections. Select holes as far apart as possible to increase door arm rigidity and attach using the bolts and nuts.
5. Pull the emergency release handle toward the garage door opener until the trolley release arm is horizontal. The trolley will re-engage automatically when the garage door opener is activated.

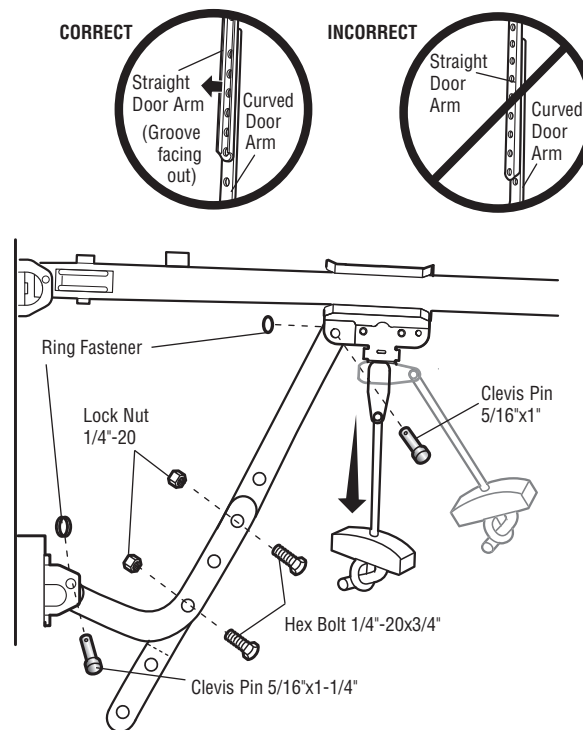
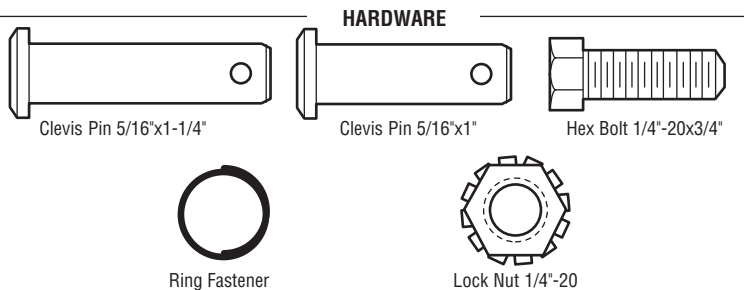

# Installation

## STEP 10 Install the door control

### **WARNING**

To prevent possible **SERIOUS INJURY** or **DEATH** from electrocution:

- Be sure power is **NOT** connected **BEFORE** installing door control.
- Connect **ONLY** to 12 VOLT low voltage wires.

To prevent possible **SERIOUS INJURY** or **DEATH** from a closing garage door:

- Install door control within sight of garage door, out of reach of children at a minimum height of 5 feet (1.5 m), and away from **ALL** moving parts of door.
- **NEVER** permit children to operate or play with door control push buttons or remote control transmitters.
- Activate door **ONLY** when it can be seen clearly, is properly adjusted, and there are no obstructions to door travel.
- **ALWAYS** keep garage door in sight until completely closed. **NEVER** permit anyone to cross path of closing garage door.

### INTRODUCTION

Install the door control within sight of the door at a minimum height of 5 feet (1.5 m) where small children cannot reach, and away from the moving parts of the door.

**NOTE:** Your product may look different than the illustrations.

### HARDWARE



Screw 6ABx1" (2)

1. Strip 1/4" (6 mm) of insulation from one end of the wire and separate the wires.
2. Connect one wire to each of the two screws on the back of the door control. The wires can be connected to either screw.
3. Mount the door control with the hardware provided.

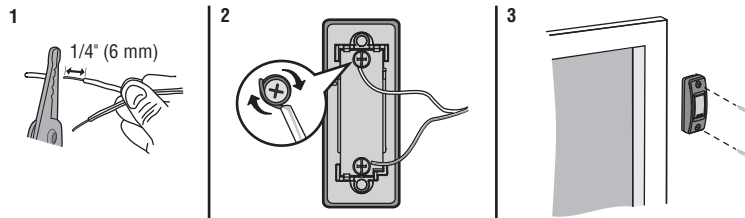

# Installation

## STEP 11 Wire the door control to the garage door opener

### HARDWARE

Insulated Staple  
(Not Shown)

1. Run the white and red/white wire from the door control to the garage door opener. Attach the wire to the wall and ceiling with the staple (not applicable for gang box or pre-wired installations). Do not pierce the wire with the staple as this may cause a short or an open circuit.
2. Strip 7/16 inch (11 mm) of insulation from the end of the wire near the garage door opener.
3. Connect the wire to the red and white terminals on the garage door opener. If your garage is pre-wired make sure you use the same wires that are connected to the door control. To insert or release wires from the terminal, push in the tab with screwdriver tip.

1

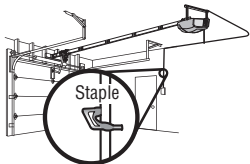

2

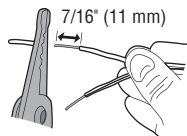

3

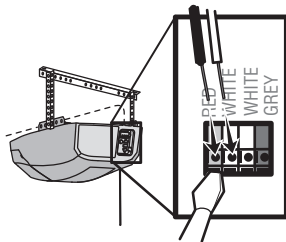

## STEP 12 Attach the warning labels

1. Attach the entrapment warning label on the wall near the door control with tacks or staples.
2. Clean surface and attach the manual release/safety reverse test label in a visible location on the inside of the garage door.

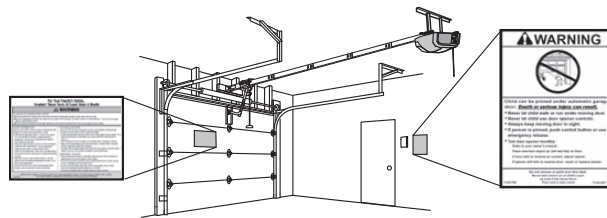

# Installation

## STEP 13 Install the Protector System®

### **WARNING**

Be sure power is NOT connected to the garage door opener BEFORE installing the safety reversing sensor.

To prevent SERIOUS INJURY or DEATH from closing garage door:

- Correctly connect and align the safety reversing sensor. This required safety device MUST NOT be disabled.
- Install the safety reversing sensor so beam is NO HIGHER than 6" (15 cm) above garage floor.

### IMPORTANT INFORMATION ABOUT THE SAFETY REVERSING SENSORS

**The safety reversing sensors must be connected and aligned correctly before the garage door opener will move in the down direction.**

The sending sensor (with an amber LED) transmits an invisible light beam to the receiving sensor (with a green LED). If an obstruction breaks the light beam while the door is closing, the door will stop and reverse to the full open position, and the garage door opener lights will flash 10 times.

**NOTE:** For energy efficiency the garage door opener will enter sleep mode when the door is fully closed. The sleep mode shuts the garage door opener down until activated. The sleep mode is sequenced with the garage door opener light bulb; as the light bulb turns off the sensor LEDs will turn off and whenever the garage door opener lights turn on the sensor LEDs will light. The garage door opener will not go into the sleep mode until the garage door opener has completed 5 cycles upon power up.

When installing the safety reversing sensors check the following:

- Sensors are installed inside the garage, one on either side of the door.
- Sensors are facing each other with the lenses aligned and the receiving sensor lens does not receive direct sunlight.
- Sensors are no more than 6 inches (15 cm) above the floor and the light beam is unobstructed.

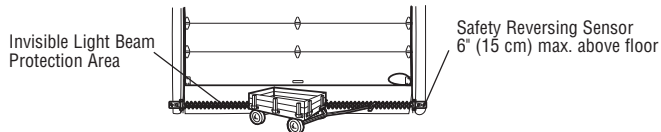

Facing the door from inside the garage

### HARDWARE

Carriage Bolt  
1/4"-20x1/2"

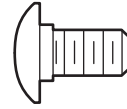

Wing Nut  
1/4"-20



The safety reversing sensors can be attached to the door track, the wall, or the floor. The sensors should be no more than 6 inches (15 cm) above the floor. If the door track will not support the sensor bracket a wall installation is recommended. Choose one of the following installations.

### OPTION A DOOR TRACK INSTALLATION

1. Slide the curved arms of the sensor bracket around the edge of the door track. Snap into place so that the sensor bracket is flush against the track.
2. Slide the carriage bolt into the slot on each sensor.
3. Insert the bolt through the hole in the sensor bracket and attach with the wing nut. The lenses on both sensors should point toward each other. Make sure the lens is not obstructed by the sensor bracket.

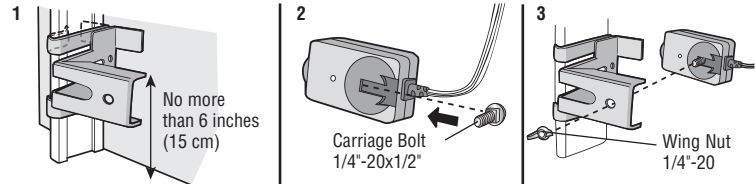

# Installation

## STEP 13 Install the Protector System® (continued) OPTION B WALL INSTALLATION

If additional clearance is needed an extension bracket (not provided) or wood blocks can be used. Make sure each bracket has the same amount of clearance so they will align correctly.

1. Position the sensor bracket against the wall with the curved arms facing the door. Make sure there is enough clearance for the beam to be unobstructed. Mark holes.
2. Drill 3/16 inch pilot holes for each sensor bracket and attach the sensor brackets to the wall using lag screws (not provided).
3. Slide the carriage bolt into the slot on each sensor.
4. Insert the bolt through the hole in the sensor bracket and attach with the wing nut. The lenses on both sensors should point toward each other. Make sure the lens is not obstructed by the sensor bracket.

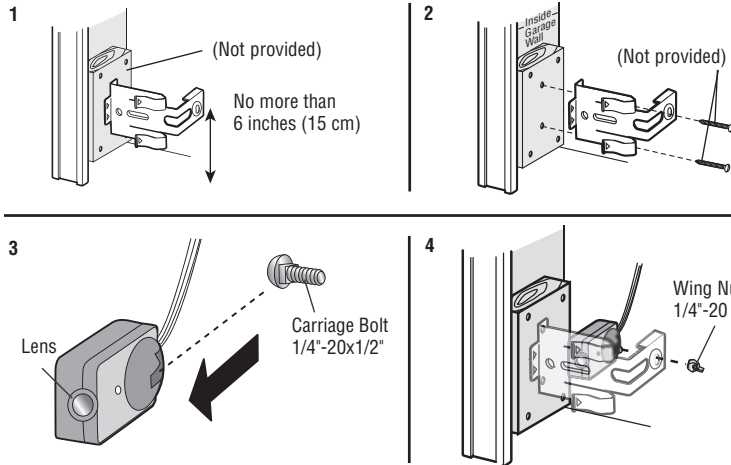

## OPTION C FLOOR INSTALLATION

Use an extension bracket (not provided) or wood block to raise the sensor bracket if needed.

1. Carefully measure the position of both sensor brackets so they will be the same distance from the wall and unobstructed.
2. Attach the sensor brackets to the floor using concrete anchors (not provided).
3. Slide the carriage bolt into the slot on each sensor.
4. Insert the bolt through the hole in the sensor bracket and attach with the wing nut. The lenses on both sensors should point toward each other. Make sure the lens is not obstructed by the sensor bracket.

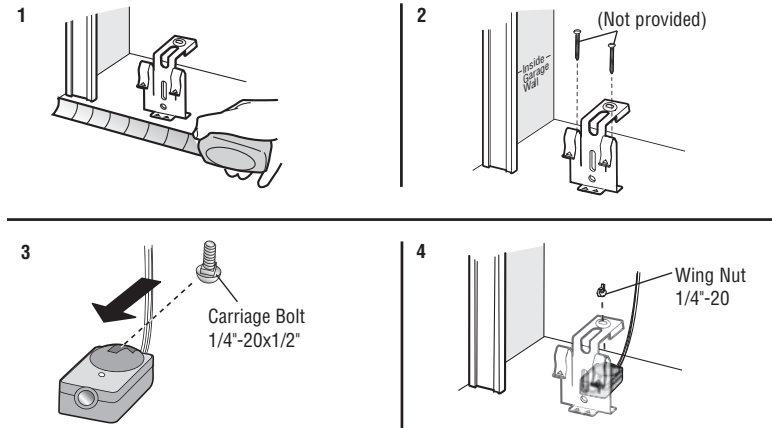

# Installation

## STEP 14 Wire the Safety Reversing Sensors

If your garage already has wires installed for the safety reversing sensors, proceed to page 23.

### HARDWARE

Insulated Staple  
(Not Shown)

### OPTION A INSTALLATION WITHOUT PRE-WIRING

1. Run the wire from both sensors to the garage door opener. Attach the wire to the wall and ceiling with the staples.
2. Strip 7/16 inch (11 mm) of insulation from each set of wires. Separate the wires. Twist the white wires together. Twist the white/black wires together.
3. Insert the white wires into the white terminal on the garage door opener. Insert the white/black wires into the grey terminal on the garage door opener. To insert or remove the wires from the terminal, push in the tab with a screwdriver tip.

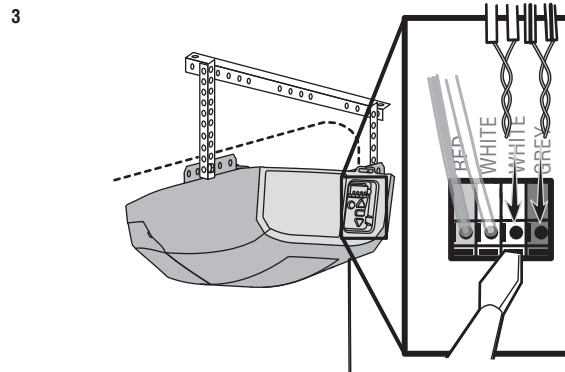
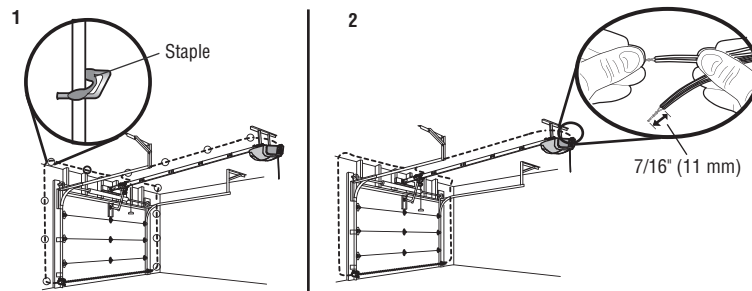

# Installation

## STEP 14 Wire the Safety Reversing Sensors (continued)

### OPTION B PRE-WIRED INSTALLATION

1. Cut the end of the safety reversing sensor wire, making sure there is enough wire to reach the pre-installed wires from the wall.
2. Separate the safety reversing sensor wires and strip 7/16 inch (11 mm) of insulation from each end. Choose two of the pre-installed wires and strip 7/16 inch (11 mm) of insulation from each end. Make sure that you choose the same color pre-installed wires for each sensor.
3. Connect the pre-installed wires to the sensor wires with wire nuts making sure the colors correspond for each sensor. For example, the white wire would connect to the yellow wire and the white/black wire would connect to the purple wire.
4. At the garage door opener, strip 7/16 inch (11 mm) of insulation from each end of the wires previously chosen for the safety reversing sensors. Twist the like-colored wires together.
5. Insert the wires connected to the white safety sensor wires to the white terminal on the garage door opener. Insert the wires that are connected to the white/black safety sensor wires to the grey terminal on the garage door opener.

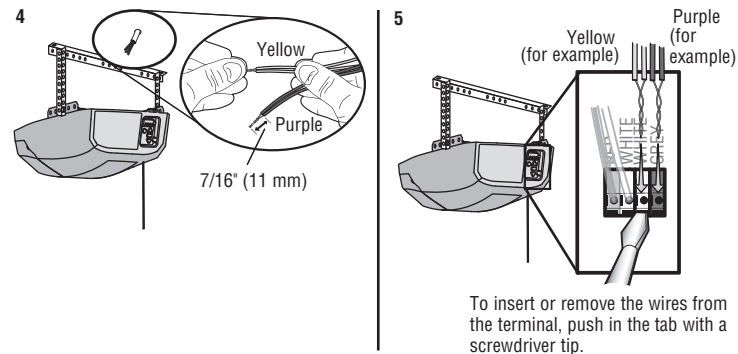
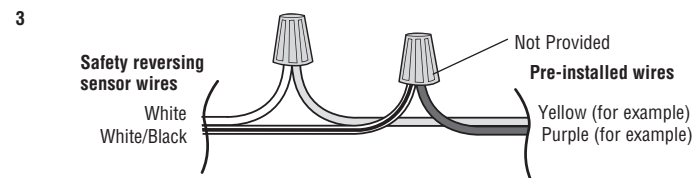
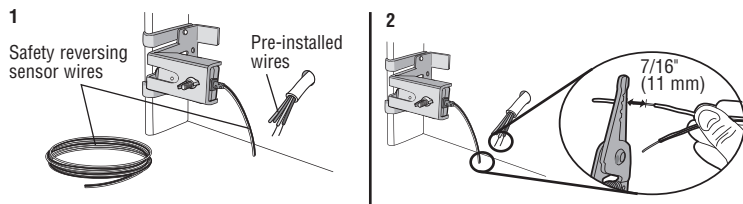



# Installation

## STEP 15 Connect power

### **WARNING**

To prevent possible **SERIOUS INJURY** or **DEATH** from electrocution or fire:

- Be sure power is **NOT** connected to the opener, and disconnect power to circuit **BEFORE** removing cover to establish permanent wiring connection.
- Garage door installation and wiring **MUST** be in compliance with **ALL** local electrical and building codes.
- **NEVER** use an extension cord, 2-wire adapter, or change plug in any way to make it fit outlet. Be sure the opener is grounded.

**To avoid installation difficulties, do not run the opener at this time.**

To reduce the risk of electric shock, your garage door opener has a grounding type plug with a third grounding pin. This plug will only fit into a grounding type outlet. If the plug doesn't fit into the outlet you have, contact a qualified electrician to install the proper outlet. **DO NOT** change the plug in any way.

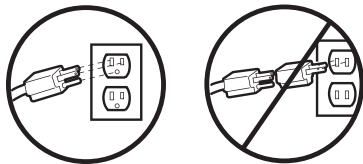

**THERE ARE TWO OPTIONS FOR CONNECTING POWER:**

### **OPTION A** TYPICAL WIRING

1. Plug in the garage door opener into a grounded outlet.
2. **DO NOT** run garage door opener at this time.

### **OPTION B** PERMANENT WIRING

If permanent wiring is required by your local code, refer to the following procedure. To make a permanent connection through the 7/8 inch hole in the top of the motor unit (according to local code):

1. Be sure power is **NOT** connected to the opener, and disconnect power to the circuit.
2. Remove the motor unit cover screws and set the cover aside.
3. Cut the power cord 6 inches (15.2 cm) from the top of the garage door opener.
4. Remove the strain relief.
5. Pull the power cord wires back into the garage door opener.
6. Install conduit or flex cable adapter in the 7/8 inch hole.
7. Run the permanent wires through the conduit in the 7/8 inch hole. Strip the insulation from the ends of all wires.
8. Connect the black (line) wire to the existing black wire; the white (neutral) wire to the existing white wire; and the ground wire to the existing green ground wire with wire nuts. The opener must be grounded.
9. Properly secure the wires with plastic ties so that the wires do not come in contact with moving parts.

### **PERMANENT WIRING CONNECTION**

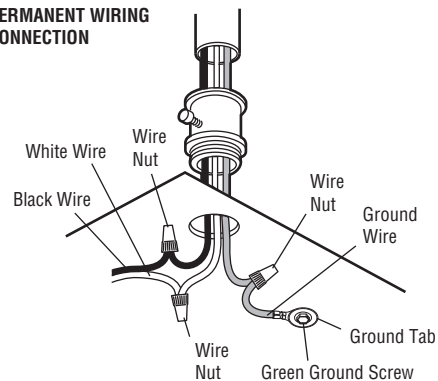

# Installation

## STEP 16 Aligning the safety reversing sensors

The door will not close if the sensors have not been installed and aligned correctly.

When the light beam is obstructed or misaligned while the door is closing, the door will reverse and the garage door opener lights will flash ten times. If the door is already open, it will not close.

1. Check to make sure the LEDs in both sensors are glowing steadily. The LEDs in both sensors will glow steadily if they are aligned and wired correctly.

The sensors can be aligned by loosening the wing nuts, aligning the sensors, and tightening the wing nuts.

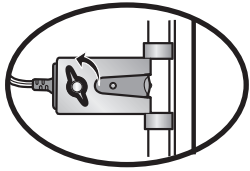

If the receiving sensor is in direct sunlight, switch it with sending sensor so it is on the opposite side of the door.

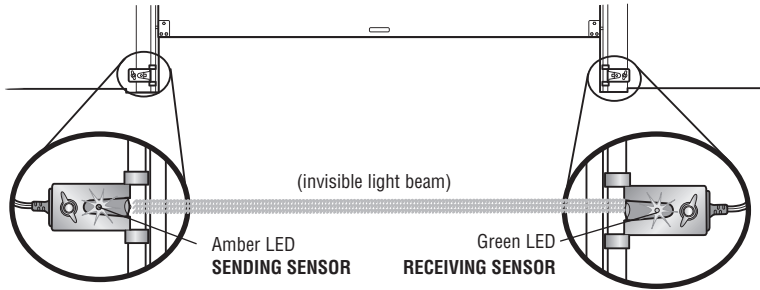

### IF THE AMBER LED ON THE SENDING SENSOR IS NOT GLOWING:

1. Make sure there is power to the garage door opener.
2. Make sure the sensor wire is not shorted/broken.
3. Make sure the sensor has been wired correctly: white wires to white terminal and white/black wires to grey terminal.

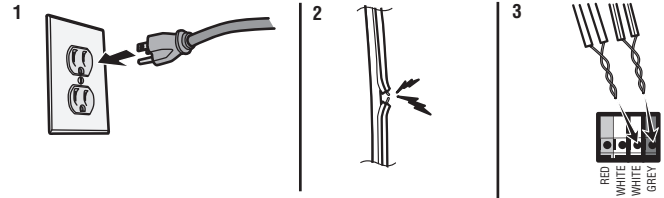

### IF THE GREEN LED ON THE RECEIVING SENSOR IS NOT GLOWING:

1. Make sure the sensor wire is not shorted/broken.
2. Make sure the sensors are aligned.

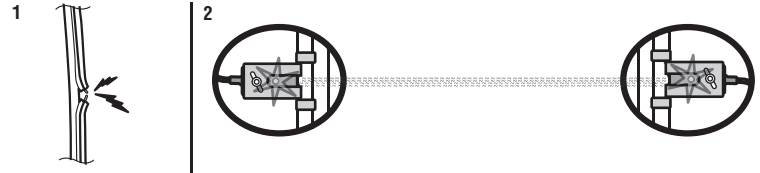

## STEP 17 Ensure the door control is wired correctly

The LED behind the push button on the door control will blink if installed correctly.

# Adjustments

## Introduction

### **WARNING**

Without a properly installed safety reversal system, persons (particularly small children) could be **SERIOUSLY INJURED** or **KILLED** by a closing garage door.

- Incorrect adjustment of garage door travel limits will interfere with proper operation of safety reversal system.
- After ANY adjustments are made, the safety reversal system **MUST** be tested. Door **MUST** reverse on contact with 1-1/2" (3.8 cm) high object (or 2x4 laid flat) on floor.

### **CAUTION**

To prevent damage to vehicles, be sure fully open door provides adequate clearance.

Your garage door opener is designed with electronic controls to make setup and adjustments easy. The adjustments allow you to program where the door will stop in the open (UP) and close (DOWN) position. The electronic controls sense the amount of force required to open and close the door. The force is adjusted automatically when you program the travel.

**NOTE:** *If anything interferes with the door's upward travel it will stop. If anything interferes with the door's downward travel, it will reverse.*

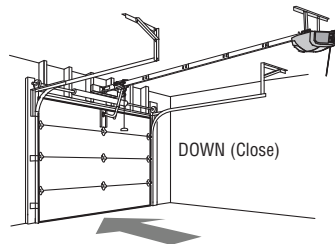
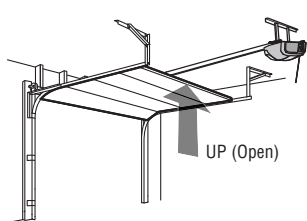

## Programming Buttons

### Programming Buttons

The programming buttons are located on the left side panel of the garage door opener and are used to program the travel. While programming, the UP and DOWN buttons can be used to move the door as needed.

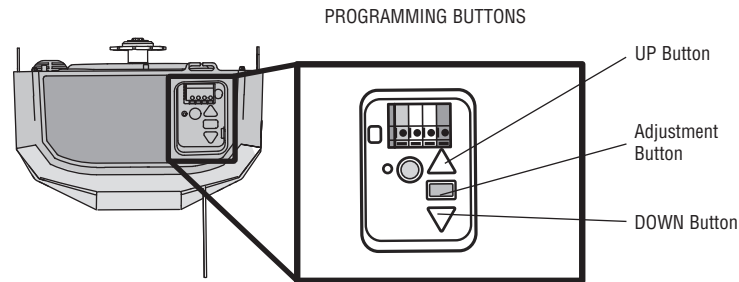

Proceed to the next page for instructions on how to program the travel.

To watch a short instructional video on how to program the travel on your new garage door opener use your smartphone to read the QR Code:



# Adjustments

## STEP 1 Program the Travel

### **WARNING**

Without a properly installed safety reversal system, persons (particularly small children) could be **SERIOUSLY INJURED** or **KILLED** by a closing garage door.

- Incorrect adjustment of garage door travel limits will interfere with proper operation of safety reversal system.
- After ANY adjustments are made, the safety reversal system **MUST** be tested. Door **MUST** reverse on contact with 1-1/2" (3.8 cm) high object (or 2x4 laid flat) on floor.

While programming, the UP and DOWN buttons can be used to move the door as needed.

1. Press and hold the Adjustment Button until the UP Button begins to flash.
2. Press and hold the UP Button until the door is in the desired UP position.
3. Once the door is in the desired UP position press and release the Adjustment Button. The garage door opener lights will flash twice and the DOWN Button will begin to flash.
4. Press and hold the DOWN button until the door is in the desired DOWN position.
5. Once the door is in the desired DOWN position press and release the Adjustment Button. The garage door opener lights will flash twice and the UP Button will begin to flash.
6. Press and release the UP Button. When the door travels to the programmed UP position, the DOWN Button will begin to flash.
7. Press and release the DOWN Button. The door will travel to the programmed DOWN position. Programming is complete.

\* If the garage door opener lights are flashing 5 times during the steps for Program the Travel, the programming has timed out. If the garage door opener lights are flashing 10 times during the steps for Program the Travel, the safety reversing sensors are misaligned or obstructed (refer to page 28). When the sensors are aligned and unobstructed, cycle the door through a complete up and down cycle using the remote control or the UP and DOWN buttons. Programming is complete. If you are unable to operate the door up and down, repeat the steps for Programming the Travel.

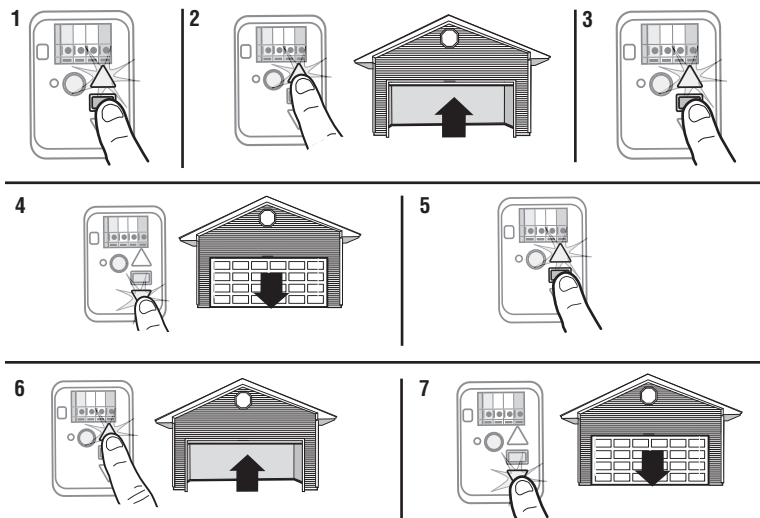
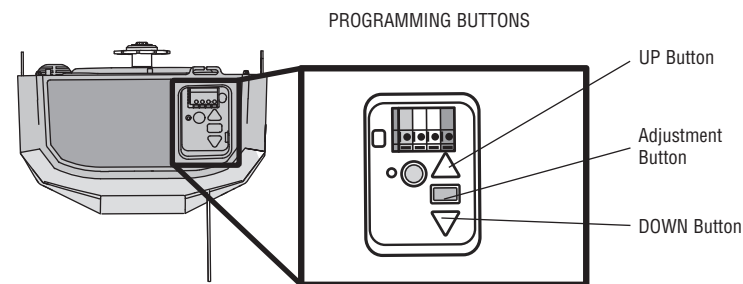

# Adjustments

## STEP 2 Test the Safety Reversal System

### WARNING

Without a properly installed safety reversal system, persons (particularly small children) could be SERIOUSLY INJURED or KILLED by a closing garage door.

- Safety reversal system MUST be tested every month.
- After ANY adjustments are made, the safety reversal system MUST be tested. Door MUST reverse on contact with 1-1/2" (3.8 cm) high object (or 2x4 laid flat) on the floor.

1. With the door fully open, place a 1-1/2 inch (3.8 cm) board (or a 2x4 laid flat) on the floor, centered under the garage door.
2. Operate the door in the down direction. The door MUST reverse on striking the obstruction.

If the door stops and does not reverse on the obstruction, the down travel needs to be increased (refer to Adjustment Step 1). Repeat the test. When the door reverses upon contact with the 1-1/2 inch board, remove the board and open/close the door 3 or 4 times to test the adjustment. If the garage door opener continues to fail the safety reversal test, call a trained door systems technician.

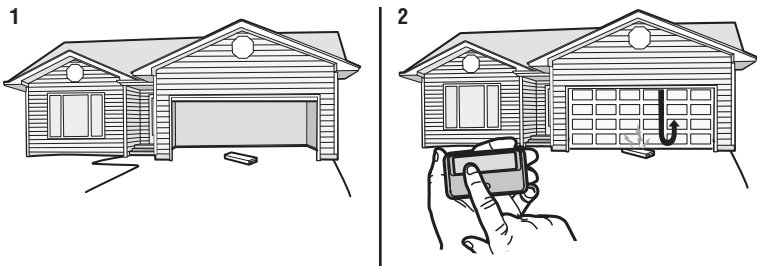

## STEP 3 Test the Protector System®

### WARNING

Without a properly installed safety reversing sensor, persons (particularly small children) could be SERIOUSLY INJURED or KILLED by a closing garage door.

1. Press the remote control push button to open the door.
2. Place the opener carton in the path of the door.
3. Press the remote control push button to close the door. The door will not move more than an inch (2.5 cm), and the opener lights will flash.

The garage door opener will not close from a remote control if the LED in either safety reversing sensor is off (alerting you to the fact that the sensor is misaligned or obstructed). If the garage door opener closes the door when the safety reversing sensor is obstructed (and the sensors are no more than 6 inches [15 cm] above the floor), call for a trained door systems technician.

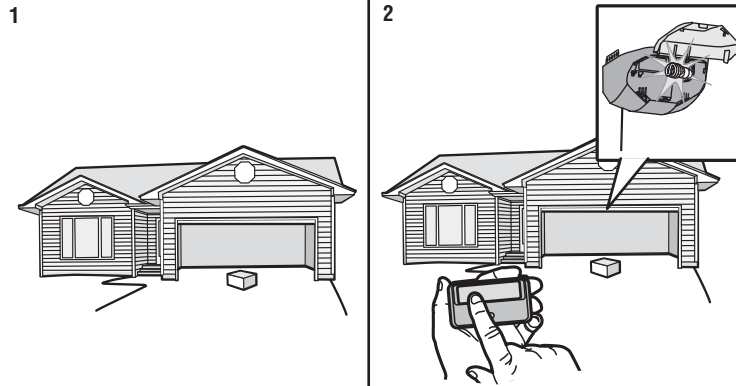

### IMPORTANT SAFETY INSTRUCTIONS



### To reduce the risk of SEVERE INJURY or DEATH:

1. READ AND FOLLOW ALL WARNINGS AND INSTRUCTIONS.
2. ALWAYS keep remote controls out of reach of children. NEVER permit children to operate or play with garage door control push buttons or remote controls.
3. ONLY activate garage door when it can be seen clearly, it is properly adjusted, and there are no obstructions to door travel.
4. ALWAYS keep garage door in sight and away from people and objects until completely closed. NO ONE SHOULD CROSS THE PATH OF THE MOVING DOOR.
5. NO ONE SHOULD GO UNDER A STOPPED, PARTIALLY OPENED DOOR.
6. If possible, use emergency release handle to disengage trolley ONLY when garage door is CLOSED. Use caution when using this release with the door open. Weak or broken springs or unbalanced door could result in an open door falling rapidly and/or unexpectedly and increasing the risk of SEVERE INJURY or DEATH.
7. NEVER use emergency release handle unless garage doorway is clear of persons and obstructions.
8. NEVER use handle to pull garage door open or closed. If rope knot becomes untied, you could fall.
9. After ANY adjustments are made, the safety reversal system MUST be tested.
10. Safety reversal system MUST be tested every month. Garage door MUST reverse on contact with 1-1/2" (3.8 cm) high object (or a 2x4 laid flat) on the floor. Failure to adjust the garage door opener properly increases the risk of SEVERE INJURY or DEATH.
11. ALWAYS KEEP GARAGE DOOR PROPERLY BALANCED (see page 1). An improperly balanced door may NOT reverse when required and could result in SEVERE INJURY or DEATH.
12. ALL repairs to cables, spring assemblies and other hardware, ALL of which are under EXTREME tension, MUST be made by a trained door systems technician.
13. ALWAYS disconnect electric power to garage door opener BEFORE making ANY repairs or removing covers.

### 14. SAVE THESE INSTRUCTIONS.

# Operation

## Features

Your garage door opener is equipped with features to provide you with greater control over your garage door operation.

### REMOTE CONTROLS AND DOOR CONTROLS

Your garage door opener has already been programmed at the factory to operate with your remote control, which changes with each use, randomly accessing over 100 billion new codes.

Accessories	MEMORY CAPACITY
Remote Controls	Up to 8
Door Controls	Up to 2
Keyless Entries	Up to 1

### THE PROTECTOR SYSTEM® (SAFETY REVERSING SENSORS)

When properly connected and aligned, the safety reversing sensors will detect an obstruction in the path of the infrared beam. If an obstruction breaks the infrared beam while the door is closing, the door will stop and reverse to full open position, and the opener lights will flash 10 times. If the door is fully open, and the safety reversing sensors are not installed, or are misaligned, the door will not close from a remote control. However, you can close the door if you hold the button on the door control or keyless entry until the door is fully closed. The safety reversing sensors do not effect the opening cycle.

## LIGHTS

The garage door opener light bulb(s) will turn on when the opener is initially plugged in; power is restored after interruption, or when the garage door opener is activated. The lights will turn off automatically after 4-1/2 minutes. An incandescent A19 light bulb (60 watt maximum) or for maximum energy efficiency a 23W (100W equivalent) compact fluorescent light (CFL) bulb may be used. **NOTE:** *Do not use halogen, short neck, or specialty light bulbs as these may overheat the unit. The use of LED bulbs may reduce the operating range or performance of your remote controls.*

### Light Feature

The garage door opener is equipped with an added feature; the lights will turn on when someone enters through the open garage door and the safety reversing sensor infrared beam is broken.

# Operation

## Using Your Garage Door Opener

The garage door opener can be activated through a wall-mounted door control, remote control, or wireless keyless entry.

When the door is closed and the garage door opener is activated the door will open. If the door senses an obstruction or is interrupted while opening the door will stop. When the door is in any position other than closed and the garage door opener is activated the door will close. If the garage door opener senses an obstruction while closing, the door will reverse. If the obstruction interrupts the sensor beam the garage door opener lights will blink 10 times. However, you can close the door if you hold the button on the door control or keyless entry until the door is fully closed. The safety reversing sensors do not affect the opening cycle.

The safety reversing sensor must be connected and aligned correctly before the garage door opener will move in the down direction.

## Using the Push Button Door Control

**SYNCHRONIZE THE DOOR CONTROL:** To synchronize the door control to the garage door opener, press the push button until the garage door opener activates (it may take up to 3 presses).

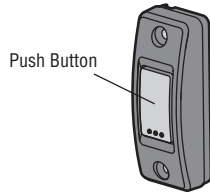

## Remote Control

**Your remote control has been programmed at the factory to operate with your garage door opener.**

Older Chamberlain remote controls are NOT compatible. Programming can be done through the learn button on the garage door opener. To program additional accessories refer to the instructions provided with the accessory or visit [www.chamberlain.com](http://www.chamberlain.com). If your vehicle is equipped with a Homelink®, you may require an external adapter depending on the make, model, and year of your vehicle. Visit [www.homelink.com](http://www.homelink.com) for additional information.

### TO ADD, REPROGRAM, OR CHANGE A REMOTE CONTROL/KEYLESS ENTRY PIN

1. Press and immediately release the Learn button.
2. **Remote Control:**  
Press and hold the button on the remote control that you wish to use.

#### Keyless Entry:

Enter a 4-digit personal identification number (PIN) of your choice on the keyless entry keypad. Then press the ENTER button.

The garage door opener lights will flash (or two clicks will be heard) when the code has been programmed. Repeat the steps for programming additional remote controls or keyless entry devices.

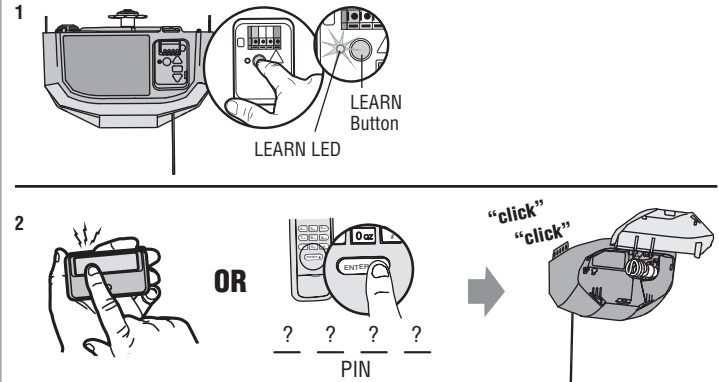



# Operation

## To Erase the Memory

### ERASE ALL REMOTE CONTROLS AND KEYLESS ENTRIES

1. Press and hold the LEARN button on garage door opener until the learn LED goes out (approximately 6 seconds). All remote control and keyless entry codes are now erased. Reprogram any accessory you wish to use.

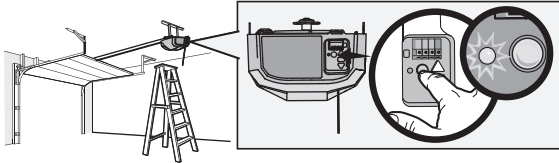

## To Open the Door Manually

### **WARNING**

To prevent possible **SERIOUS INJURY** or **DEATH** from a falling garage door:

- If possible, use emergency release handle to disengage trolley **ONLY** when garage door is **CLOSED**. Weak or broken springs or unbalanced door could result in an open door falling rapidly and/or unexpectedly.
- **NEVER** use emergency release handle unless garage doorway is clear of persons and obstructions.
- **NEVER** use handle to pull door open or closed. If rope knot becomes untied, you could fall.

### DISCONNECT THE TROLLEY

1. The door should be fully closed if possible.
2. Pull down on the emergency release handle so the trolley release arm snaps to the vertical position. The door can now be raised and lowered as often as necessary.

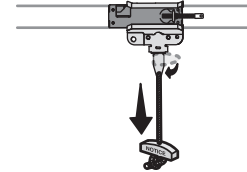

### TO RECONNECT THE TROLLEY

1. Pull the emergency release handle toward the garage door opener so the trolley release arm snaps to the horizontal position. The trolley will reconnect on the next UP or DOWN operation, either manually or by using the door control or remote control.

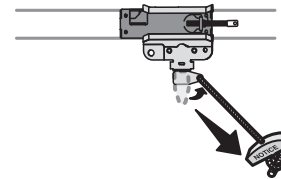

# Maintenance

## Maintenance Schedule

### EVERY MONTH

- Manually operate door. If it is unbalanced or binding, call a trained door systems technician.
- Check to be sure door opens and closes fully. Adjust if necessary, see page 26.
- Test the safety reversal system. Adjust if necessary, see page 28.

### EVERY YEAR

- Oil door rollers, bearings and hinges. The garage door opener does not require additional lubrication. Do not grease the door tracks.

## The Remote Control Battery

### ⚠ WARNING

To prevent possible **SERIOUS INJURY** or **DEATH**:

- NEVER allow small children near batteries.
- If battery is swallowed, immediately notify doctor.

To reduce risk of fire, explosion or chemical burn:

- Replace **ONLY** with 3V CR2032 coin batteries.
- **DO NOT** recharge, disassemble, heat above 212°F (100°C) or incinerate.

The 3V CR2032 lithium battery should produce power for up to 3 years. If the battery is low, the remote control's LED will not flash when the button is pressed.

To replace battery, pry open the case first in the middle (1), then at each side (2 and 3) with the visor clip. Replace the batteries with only 3V CR2032 coin cell batteries. Insert battery positive side up.

Dispose of old batteries properly.

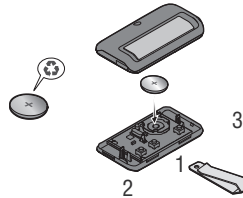

**NOTICE:** This device complies with Part 15 of the FCC rules and Industry Canada (IC) licence-exempt RSS standard(s). Operation is subject to the following two conditions: (1) this device may not cause harmful interference, and (2) this device must accept any interference received, including interference that may cause undesired operation. Any changes or modifications not expressly approved by the party responsible for compliance could void the user's authority to operate the equipment. This Class B digital apparatus complies with Canadian ICES-003.

## Repair Parts

	Description	Part No.
1	Logic board	047DCT
2	Light lens	041D0166
3	Hardware bag	041A8068
4	Door arm kit: straight door arm, curved door arm, hardware bag	041A8094
5	Door control	041A7367-3

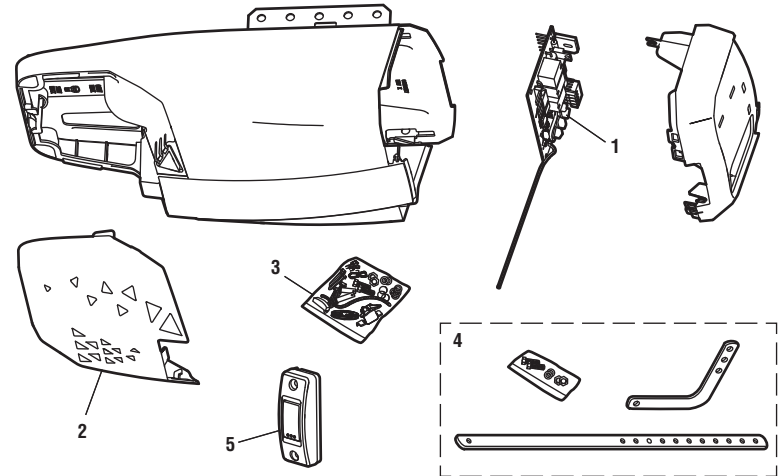

# Troubleshooting

## Diagnostic Chart

Your garage door opener is programmed with self-diagnostic capabilities. The UP and DOWN arrows on the garage door opener flash the diagnostic codes. **NOTE:** For troubleshooting questions, please visit [www.chamberlain.com](http://www.chamberlain.com).

DIAGNOSTIC CODE		SYMPTOM	SOLUTION
Up Arrow Flash(es)	Down Arrow Flash(es)		
1	1	The garage door opener will not close and the light bulbs flash.	Safety sensors are not installed, connected, or wires may be cut. Inspect sensor wires for a disconnected or cut wire.
1	2	The garage door opener will not close and the light bulbs flash.	There is a short or reversed wire for the safety sensors. Inspect safety sensor wire at all staple and connection points, replace wire or correct as needed.
1	3	The door control will not function.	The wires for the door control are shorted or the door control is faulty. Inspect door control wires at all staple and connection points, replace wire or correct as needed.
1	4	The garage door opener will not close and the light bulbs flash.	Safety sensors are misaligned or were momentarily obstructed. Realign both sensors to ensure both LEDs are steady and not flickering. Make sure nothing is hanging or mounted on the door that would interrupt the sensor's path while closing.
1	5	Door moves 6-8" stops or reverses.	Manually open and close the door. Check for binding or obstructions, such as a broken spring or door lock, correct as needed. Check wiring connections at travel module and at the logic board. Replace unit if necessary.
		No movement, only a single click.	Manually open and close the door. Check for binding or obstructions, such as a broken spring or door lock, correct as needed. Replace logic board if necessary.
		Opener hums for 1-2 seconds no movement.	Manually open and close the door. Check for binding or obstructions, such as a broken spring or door lock, correct as needed. Replace unit if necessary.
1	6	Door coasts after it has come to a complete stop.	Program travel to coasting position or have door balanced by a trained door systems technician.
2	1-5	No movement, or sound.	Replace logic board.
3	2	Unable to set the travel or retain position.	Check travel module for proper assembly, replace unit if necessary.
4	1-4	Door is moving stops or reverses.	Manually open and close the door. Check for binding or obstructions, such as a broken spring or door lock, correct as needed. If the door is binding or sticking contact a trained door systems technician. If door is not binding or sticking attempt to reprogram travel (refer to page 26).
4	5	Opener runs approximately 6-8", stops and reverses.	Communication error to travel module. Check travel module connections, replace unit if necessary.
4	6	The garage door opener will not close and the light bulbs flash.	Safety sensors are misaligned or were momentarily obstructed. Realign both sensors to ensure both LEDs are steady and not flickering. Make sure nothing is hanging or mounted on the door that would interrupt the sensor's path while closing.

# Warranty

**STOP!**

This garage door opener **WILL NOT** work until the safety reversing sensors are properly installed and aligned.

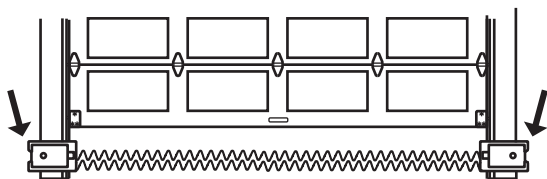

## Contact Information

For installation and service information please call:

**1-800-528-9131**

or visit:

**[www.chamberlain.com/parts-and-support](http://www.chamberlain.com/parts-and-support)**

If you are calling for support or ordering a repair part please have the following information:  
part number, part name, and model number.

Address repair parts orders to:

**The Chamberlain Group, Inc.**  
**6050 S. Country Club Road**  
**Tucson, AZ 85706**

Se dispone de manuales en francés y español en [www.chamberlain.com](http://www.chamberlain.com).

Les manuels en français et en espagnol sont disponibles sur [www.chamberlain.com](http://www.chamberlain.com).

**Register your new garage door opener at**  
**[www.prodregister.com/chamberlain](http://www.prodregister.com/chamberlain)**

## CHAMBERLAIN® ONE-YEAR LIMITED WARRANTY SIX-YEAR MOTOR LIMITED WARRANTY

The Chamberlain Group, Inc. ("Seller") warrants to the first retail purchaser of this product, for the residence in which this product is originally installed, that it is free from defect in materials and/or workmanship for a period of one year from the date of purchase and that the motor is free from defect in materials and/or workmanship for a period of six years from the date of purchase. The proper operation of this product is dependent on your compliance with the instructions regarding installation, operation, maintenance and testing. Failure to comply strictly with those instructions will void this limited warranty in its entirety.

If, during the limited warranty period, this product appears to contain a defect covered by this limited warranty, call 1-800-528-9131, toll free, before dismantling this product. Then send this product, pre-paid and insured, to our service center for warranty repair. You will be advised of shipping instructions when you call. Please include a brief description of the problem and a dated proof-of-purchase receipt with any product returned for warranty repair. Products returned to Seller for warranty repair, which upon receipt by Seller are confirmed to be defective and covered by this limited warranty, will be repaired or replaced (at Seller's sole option) at no cost to you and returned pre-paid. Defective parts will be repaired or replaced with new or factory-rebuilt parts at Seller's sole option.

**ALL IMPLIED WARRANTIES FOR THE PRODUCT, INCLUDING BUT NOT LIMITED TO ANY IMPLIED WARRANTIES OF MERCHANTABILITY AND FITNESS FOR A PARTICULAR PURPOSE, ARE LIMITED IN DURATION TO THE ONE-YEAR LIMITED WARRANTY PERIOD SET FORTH ABOVE EXCEPT THE IMPLIED WARRANTIES WITH RESPECT TO THE MOTOR, WHICH ARE LIMITED IN DURATION TO THE SIX-YEAR LIMITED WARRANTY PERIOD FOR THE MOTOR, AND NO IMPLIED WARRANTIES WILL EXIST OR APPLY AFTER SUCH PERIOD.** Some States do not allow limitations on how long an implied warranty lasts, so the above limitation may not apply to you.

**THIS LIMITED WARRANTY DOES NOT COVER NON-DEFECT DAMAGE, DAMAGE CAUSED BY IMPROPER INSTALLATION, OPERATION OR CARE (INCLUDING, BUT NOT LIMITED TO ABUSE, MISUSE, FAILURE TO PROVIDE REASONABLE AND NECESSARY MAINTENANCE, UNAUTHORIZED REPAIRS OR ANY ALTERATIONS TO THIS PRODUCT), LABOR CHARGES FOR REINSTALLING A REPAIRED OR REPLACED UNIT, REPLACEMENT OF BATTERIES AND LIGHT BULBS OR UNITS INSTALLED FOR NONRESIDENTIAL USE. THIS LIMITED WARRANTY DOES NOT COVER ANY PROBLEMS WITH, OR RELATING TO, THE GARAGE DOOR OR GARAGE DOOR HARDWARE, INCLUDING BUT NOT LIMITED TO THE DOOR SPRINGS, DOOR ROLLERS, DOOR ALIGNMENT OR HINGES. THIS LIMITED WARRANTY ALSO DOES NOT COVER ANY PROBLEMS CAUSED BY INTERFERENCE. ANY SERVICE CALL THAT DETERMINES THE PROBLEM HAS BEEN CAUSED BY ANY OF THESE ITEMS COULD RESULT IN A FEE TO YOU.**

**UNDER NO CIRCUMSTANCES SHALL SELLER BE LIABLE FOR CONSEQUENTIAL, INCIDENTAL OR SPECIAL DAMAGES ARISING IN CONNECTION WITH USE, OR INABILITY TO USE, THIS PRODUCT. IN NO EVENT SHALL SELLER'S LIABILITY FOR BREACH OF WARRANTY, BREACH OF CONTRACT, NEGLIGENCE OR STRICT LIABILITY EXCEED THE COST OF THE PRODUCT COVERED HEREBY. NO PERSON IS AUTHORIZED TO ASSUME FOR US ANY OTHER LIABILITY IN CONNECTION WITH THE SALE OF THIS PRODUCT.**

Some states do not allow the exclusion or limitation of consequential, incidental or special damages, so the above limitation or exclusion may not apply to you. This limited warranty gives you specific legal rights, and you may also have other rights which vary from state to state.