

GATE HARDWARE HINGES, WHEELS, GUIDE ROLLERS AND COMPONENTS

Your comprehensive hardware offering
for every gate application.



GATE HARDWARE
PRODUCT LINE
HINGES, WHEELS, GUIDE ROLLERS
AND COMPONENTS

LiftMaster

A TOTAL SOLUTION FOR EVERY APPLICATION

LiftMaster® has everything you need to deliver an integrated access solution to every customer. From gate operators and accessories to access control, our products are engineered to work together as one seamless system.



GATE OPERATORS

With state-of-the-art technology and a strong, rugged construction, you can rely on our gate operators to give you access anytime you need it.



ACCESS CONTROL

With entry systems to keypads, card readers to perimeter alert systems, our lineup of feature-rich solutions provides the perfect access system for your needs.



SAFETY ENTRAPMENT PROTECTION

LiftMaster has engineered our operators and monitored safety entrapment protection devices to work together as a UL 325 compliant system.

myQ® business™

CLOUD-BASED SOFTWARE

Enables you to manage multiple access points and multiple properties from a single dashboard on your computer or tablet from anywhere.

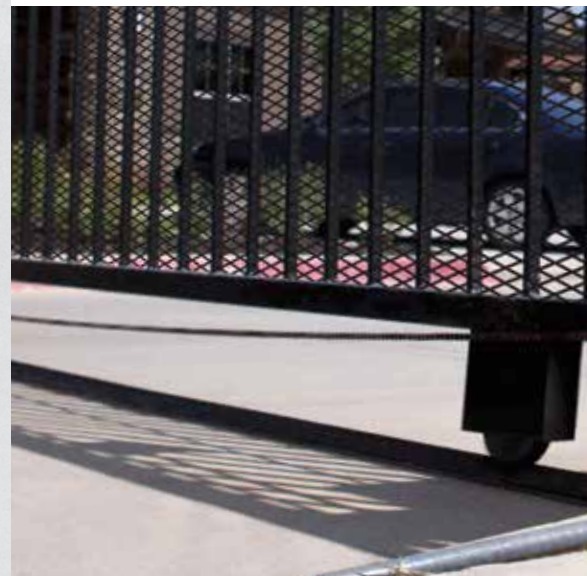
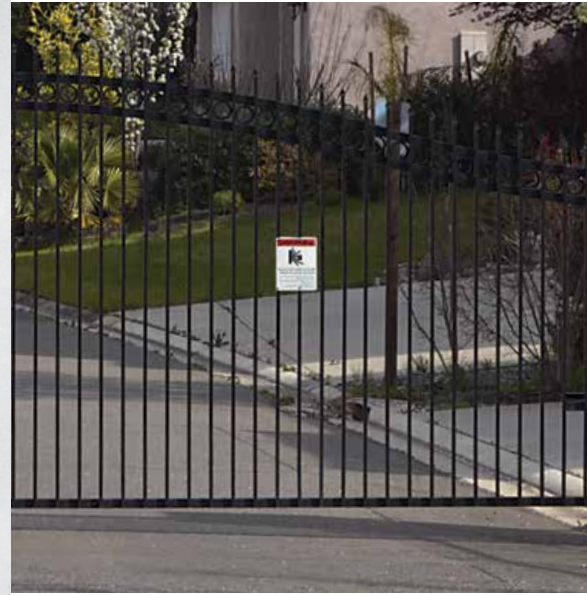

TABLE OF CONTENTS



ROLLER CAGE BEARING HINGES

- PG. 5 | STANDARD DUTY (1,000 LBS.)
- PG. 6 | ADJUSTABLE (1,000 LBS.)
- PG. 6 | TAMPERPROOF (1,000 LBS.)
- PG. 7 | HEAVY DUTY (3,000 LBS.)
- PG. 8 | SPECIALTY STANDARD DUTY (600-1000 LBS.)



SEALED ROLLER BEARING HINGES

- PG. 11 | ADJUSTABLE (2,000 LBS.)
- PG. 11 | SPECIALTY FLANGE (2,000 LBS.)

MACHINED BLOCK HINGES

- PG. 13 | POWERHINGES (1,000-3,000 LBS.)
- PG. 13 | SPECIALTY UPHILL (2,000 LBS.)



WHEELS, GUIDE ROLLERS AND COMPONENTS

- PG. 15 | WHEELS AND COMPONENTS
- PG. 17 | GUIDE ROLLERS AND COMPONENTS

ROLLER CAGE BEARING HINGES

Engineered for endurance and maximum reliability, the hardened steel, roller cage, needle-bearing system provides 5 times the weight bearing surface, largest weld surface and even-weight distribution.

Five times the weight bearing surface of the nearest large hinge

Largest weld surface attachment in the industry

Even-weight distribution from "side to side"

Grease fitting for cavity lubrication

Hardened steel roller bearing system – fully lubricated

Weight capacities from 1,000 to 3,000 lbs. per pair



HOW TO ORDER

1 | CHOOSE A MODEL

2 1 0 0

2100

Mounting: Flat Mount – Both Sides
Quantity per Box: 2
Material: All Steel
Finish: **P** **U** **Z**

2 | SELECT A FINISH

2 1 0 0 P

B BLACK

P PRIME COATED

U UNFINISHED

Z* ZINC PLATED*

3 | ORDER

To place your order visit:
Dealer.LiftMaster.com

Call 800.323.2276

Email Customer.Service@LiftMaster.com

Contact your LiftMaster® Sales Representative

STANDARD DUTY ROLLER CAGE BEARING HINGES

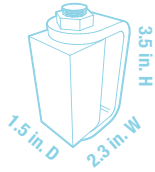

Ideal for residential and commercial applications with proven reliability you can depend on.



2 1 0 0

Mounting: Flat Mount – Both Sides
Quantity per Box: 2
Material: All Steel
Finish: P U Z



2 1 1 0

Mounting: Round Mount – Both Sides
Quantity per Box: 2
Material: All Steel
Finish: P Z



2 1 1 5

Mounting: Flat Mount to Gate – Round Mount to Post
Quantity per Box: 2
Material: All Steel
Finish: P



2 1 2 5

Mounting: Flat Mount to Gate – Bolt to Post
Quantity per Box: 2
Material: All Steel
Finish: P



2 1 5 0

Mounting: Bolt to Gate – Bolt to Post
Quantity per Box: 2
Material: All Steel
Finish: P Z B

*Electroplated Zinc Coating is tested to ASTM Classification - Protects Against Severe Exposure

ADJUSTABLE ROLLER CAGE BEARING HINGES

1,000
LBS.
PER PAIR

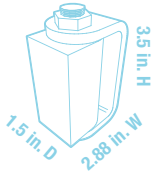

This versatile hinge combines the durability of the standard duty hinge with up to 0.5 inch of adjustability.



3 1 0 0

Mounting: Flat Mount – Both Sides
Quantity per Box: 2
Material: All Steel
Finish: P Z*



3 1 1 0

Mounting: Round Mount – Both Sides
Quantity per Box: 2
Material: All Steel
Finish: P



3 1 5 0

Mounting: Bolt to Gate – Bolt to Post
Quantity per Box: 2
Material: All Steel
Finish: P Z*

TAMPERPROOF ROLLER CAGE BEARING HINGES

1,000
LBS.
PER PAIR



Ideal for high-security sites or where privacy is necessary, this hinge's unique welded pin design eliminates tampering and dramatically reduces the spacing between the post and the gate.



2 0 6 0

Mounting: Flat Mount – Both Sides
Quantity per Box: 2
Material: All Steel
Finish: P U Z*



2 0 6 2

Mounting: Bolt to Gate – Bolt to Post
Quantity per Box: 1
Material: All Steel
Finish: P



2 0 6 4

Mounting: Round Mount – Both Sides
Quantity per Box: 2
Material: All Steel
Finish: P Z*

HEAVY DUTY ROLLER CAGE BEARING HINGES

3,000
LBS.
PER PAIR

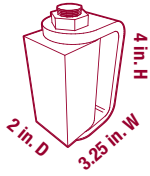

True durability for heavy and high-cycle gates with the confidence it will perform every time.



2 0 0 0

Mounting: Flat Mount – Both Sides
Quantity per Box: 2
Material: All Steel
Finish: P U Z*



2 0 1 0

Mounting: Round Mount – Both Sides
Quantity per Box: 2
Material: All Steel
Finish: P Z*



2 0 1 5

Mounting: Flat Mount to Gate – Round Mount to Post
Quantity per Box: 2
Material: All Steel
Finish: P Z*



2 0 2 5

Mounting: Flat Mount to Gate – Bolt to Post
Quantity per Box: 1
Material: All Steel
Finish: P



2 0 5 0

Mounting: Bolt to Gate – Bolt to Post
Quantity per Box: 1
Material: All Steel
Finish: P Z*

*Electroplated Zinc Coating is tested to ASTM Classification - Protects Against Severe Exposure

SPECIALTY STANDARD DUTY ROLLER CAGE BEARING HINGES

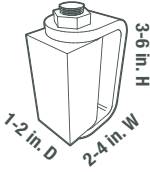

Designed for heavy or high-traffic gates, these hinges are offered in 100% Aluminum (A), 100% Stainless Steel (SS) or a combination of Aluminum and Stainless Steel (AS).



2 | 1 | 7 | 0 | A | S

Mounting: Flat Mount to Gate
(Aluminum) – Flat Mount to Post (Steel)

Quantity per Box: 2

Material: Aluminum/Steel

Dimensions:

3.5 in. H x 2.88 in. W x 1.5 in. D



2 | 1 | 8 | 0 | S | S

Mounting: Flat Mount –
Both Sides

Quantity per Box: 2

Material: Stainless Steel

Dimensions:

3.5 in. H x 3.19 in. W x 1.5 in. D

2 | 1 | 8 | 5 | S | S

Mounting: Bolt to Gate –
Bolt to Post

Quantity per Box: 2

Material: Stainless Steel

Dimensions:

5.56 in. H x 3.69 in. W x 1.5 in. D

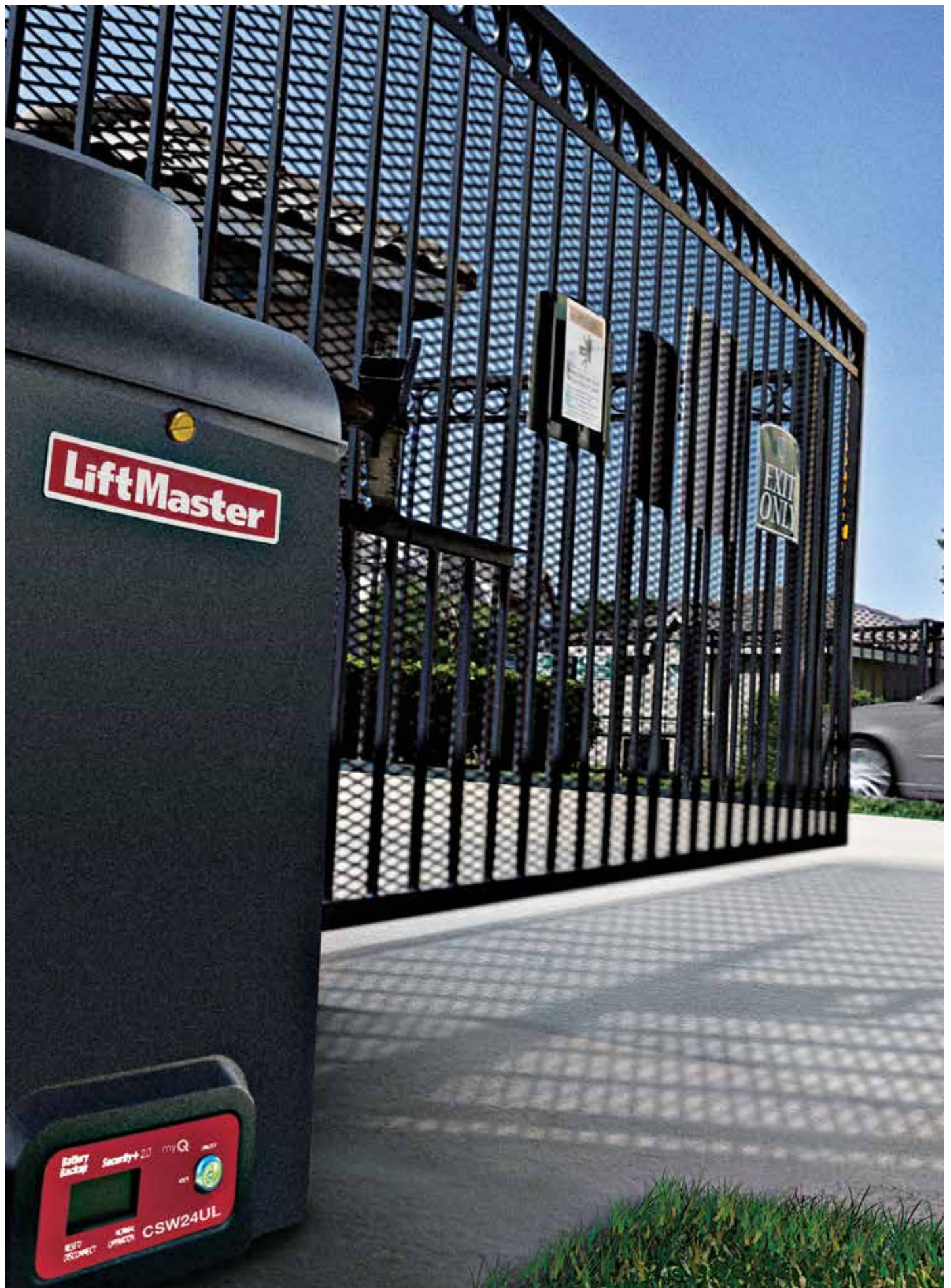

LiftMaster

Battery Backup Security+20 myQ PRO
CSW24UL

SEALED ROLLER BEARING HINGES

This versatile hinge allows you to adjust the slot in yoke up to 0.5 inch. Offered in 100% Aluminum (A) or a combination of Aluminum and Stainless Steel (AS).

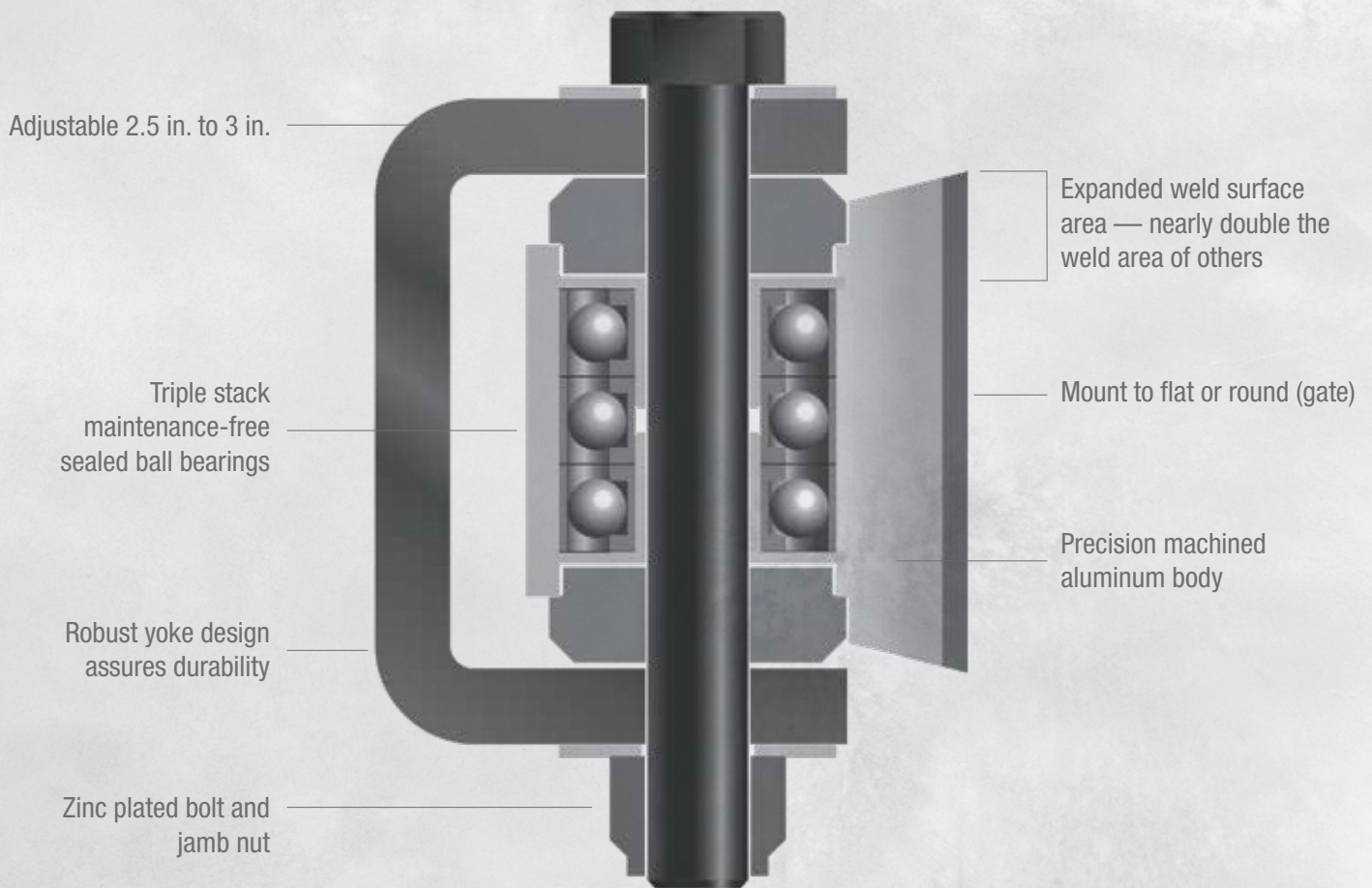

ADJUSTABLE SEALED ROLLER BEARING HINGES

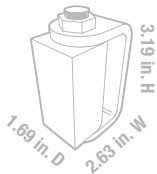

The 3-tier bearing stack combines an extra level of strength with a maintenance-free design.



3 3 0 0 A

Mounting: Flat Mount to Gate –
Flat or Round Mount to Post
Quantity per Box: 2
Material: Aluminum



3 3 0 0 A S

Mounting: Flat Mount to Gate (Steel) –
Flat or Round Mount to Post (Aluminum)
Quantity per Box: 2
Material: Aluminum/Steel



SPECIALTY FLANGE BEARING HINGE



Designed for heavy wrought iron gates, these hinges are mounted to the top and bottom edges of the gate.



S W G 6 0 0

Mounting: Flat Mount
Quantity per Box: 2
Material: Steel with High-Grade
Steel Needle Bearings
Compatible: 4 x 4 in. post



MACHINED BLOCK HINGES

Engineered to last longer and install easier, these self-lubricating ball bearing hinges are ideal for wrought iron or aluminum gates.

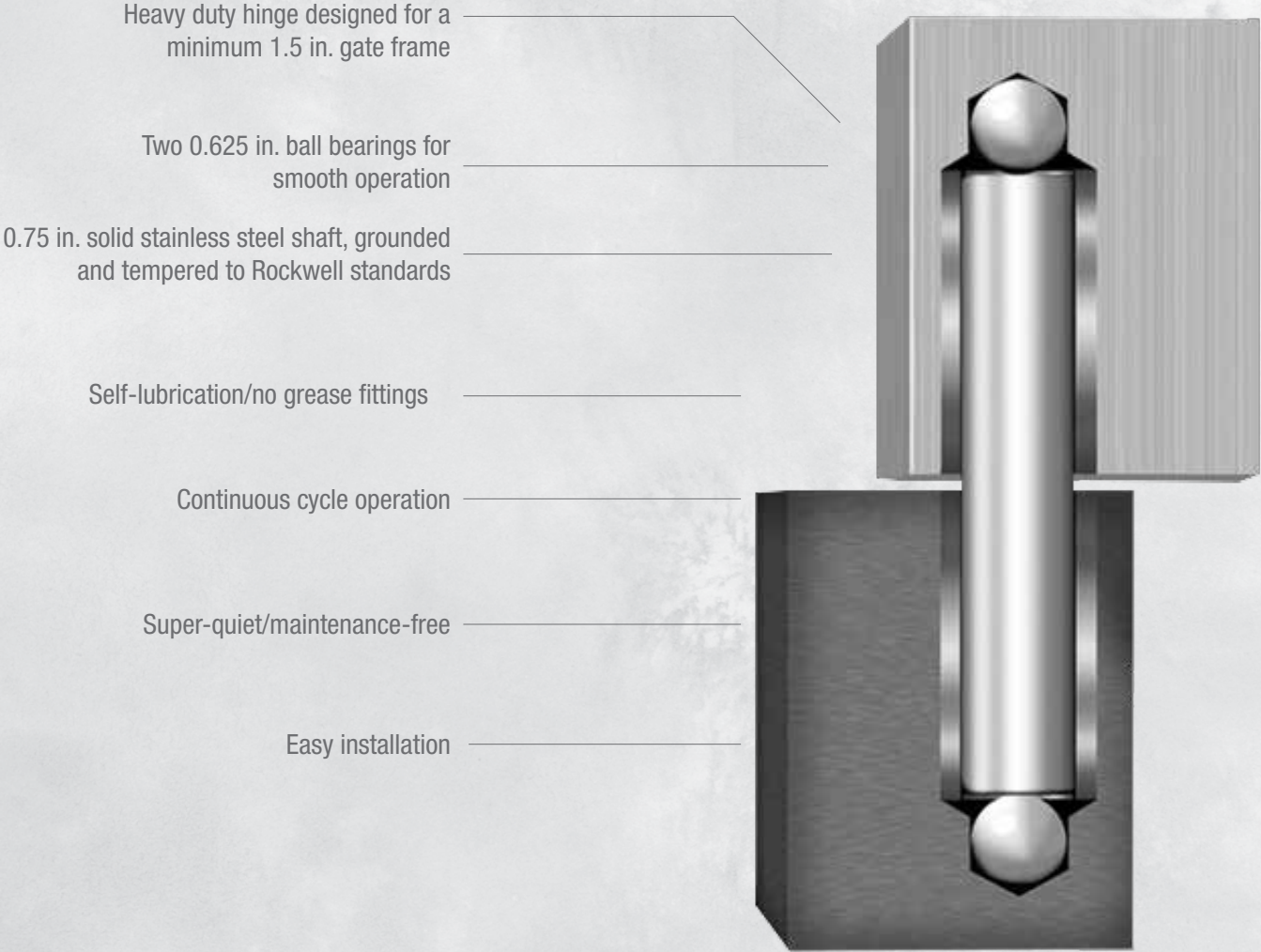

POWERHINGE® MACHINED BLOCK HINGES

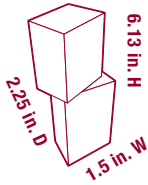

The industry standard for continuous duty maintenance-free operation.



HEAVY DUTY STEEL
3,000 LBS.

POWERHINGE

Mounting: Flat Mount
Quantity per Box: 2
Material: Steel



½ STEEL, ½ ALUMINUM
1,000 LBS.

POWERHINGE2

Mounting: Flat Mount
Quantity per Box: 2
Material: Aluminum/Steel



HEAVY DUTY ALUMINUM
1,000 LBS.

POWERHINGE3

Mounting: Flat Mount
Quantity per Box: 2
Material: Aluminum

SPECIALTY UPHILL MACHINED BLOCK HINGES



The Specialty Uphill Hinge allows a gate to swing uphill. Not for use with automatic operators.

ASTM F2200 Standard: Gate shall be designed, constructed, and installed such that their movement shall not be initiated by gravity when an automatic operator is disconnected.



SWG606

Mounting: Flat Mount
Quantity per Box: 2
Material: Steel with Bronze Bearings

WHEELS, GUIDE ROLLERS AND COMPONENTS

From the industry-leading Power Wheel® to wheel covers, guide rollers and more, LiftMaster® ensures you have the right products for a quality gate installation.

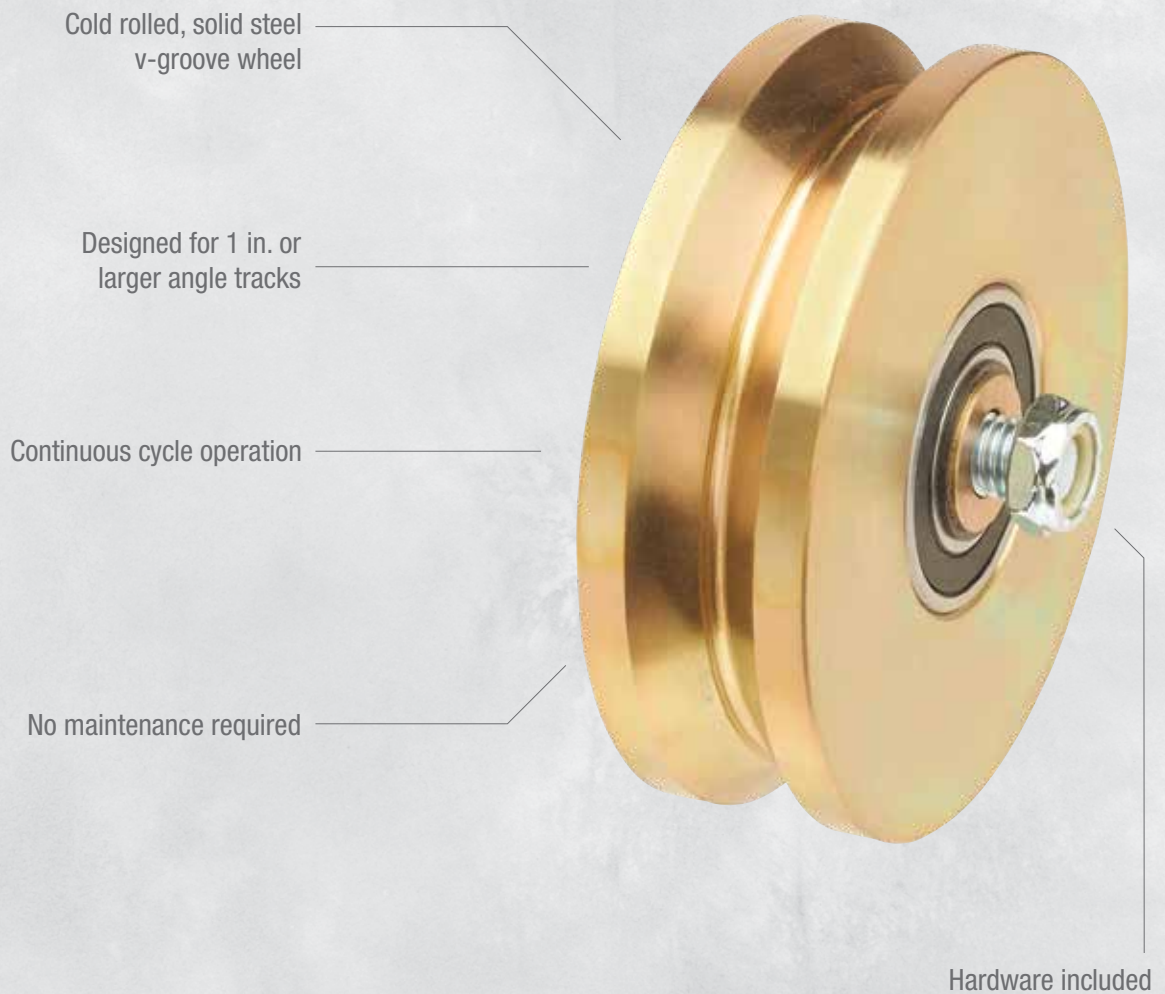

WHEELS AND COMPONENTS



4 IN.
POWER WHEELS

A H 1 0 7

Quantity per Box: 2
Finish: Gold Zinc Plating
Weight Capacity: Up to 3,000 lbs.



6 IN.
POWER WHEEL

A H 1 1 0

Quantity per Box: 1
Finish: Gold Zinc Plating
Weight Capacity: Up to 5,000 lbs.



4 IN.
POWER WHEELS

H T 3 0 0 0 V

Quantity per Box: 2
Finish: Heat-Treated Silver Zinc Plating
Weight Capacity: Up to 3,000 lbs.



6 IN.
POWER WHEEL

H T 5 0 0 0 V

Quantity per Box: 1
Finish: Heat-Treated Silver Zinc Plating
Weight Capacity: Up to 5,000 lbs.



4 IN.
STEEL WHEEL COVER

2 2 2 0 4 S

Quantity per Box: 1
Material: Steel
Finish: Unfinished
Meets ASTM F2200 Standards



6 IN.
STEEL WHEEL COVER

2 2 2 0 6 S

Quantity per Box: 1
Material: Steel
Finish: Unfinished
Meets ASTM F2200 Standards

WHEELS AND COMPONENTS



4 IN. SINGLE BRACKET

A H 1 0 3

Quantity per Box: 1
Material: Steel
Finish: Unfinished

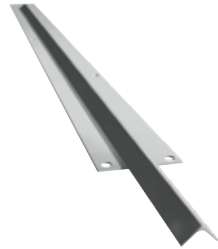

10 FT. WITH INTERLOCKING ENDS

T V 2 0 1

Quantity per Box: 1
Material: Steel
Finish: Black Powder Coated
Application: 90° angle top extends for interlocking capability. 10 ft. length by 4 in. width, anchoring holes 0.5 in. diameter.



V T R A C K

Quantity per Box: 1
Material: Unpainted 12-Gauge Hot-Dipped Galvanized Steel
Application: Single-piece design, 90° rounded angle top. 10 ft. length by 4 in. width. Multiple .375 in. diameter anchoring holes for ease of installation.



V T R A C K B L K

Quantity per Box: 1
Material: Black 12-Gauge Hot-Dipped Galvanized Steel
Application: Single-piece design, 90° rounded angle top. 10 ft. length by 4 in. width. Multiple .375 in. diameter anchoring holes for ease of installation.

GUIDE ROLLERS AND COMPONENTS



3 IN. SHIELDED
GUIDE ROLLER

2 2 4 1 3 G R

Quantity per Box: 1

Material: Zinc Plated, Commercial
Grade EPDM Non-Mar Rubber



6 IN. SHIELDED
GUIDE ROLLER

2 2 4 1 6 G R

Quantity per Box: 1

Material: Zinc Plated, Commercial
Grade EPDM Non-Mar Rubber



SHIELDED GUIDE
ROLLER BRACKET

2 2 4 1 G R B

Quantity per Box: 1

Material: Zinc Plated,
For Use in Dual-System Applications



11 IN. GUIDE ROLLER

G R 1 2 3 - R

Quantity per Box: 1

Material: Neoprene
Finish: **B G**



6 IN. ROLLER

A U H M

Quantity per Box: 1

Material: UHMW
Finish: Black



HEAVY DUTY
SLIDE LATCH

4 1 0 0 2 S

Quantity per Box: 1

Material: Steel
Application: Zinc plated latch
is flush mounted and bolts or welds
on to gate, providing locking capability
for swing gate applications.

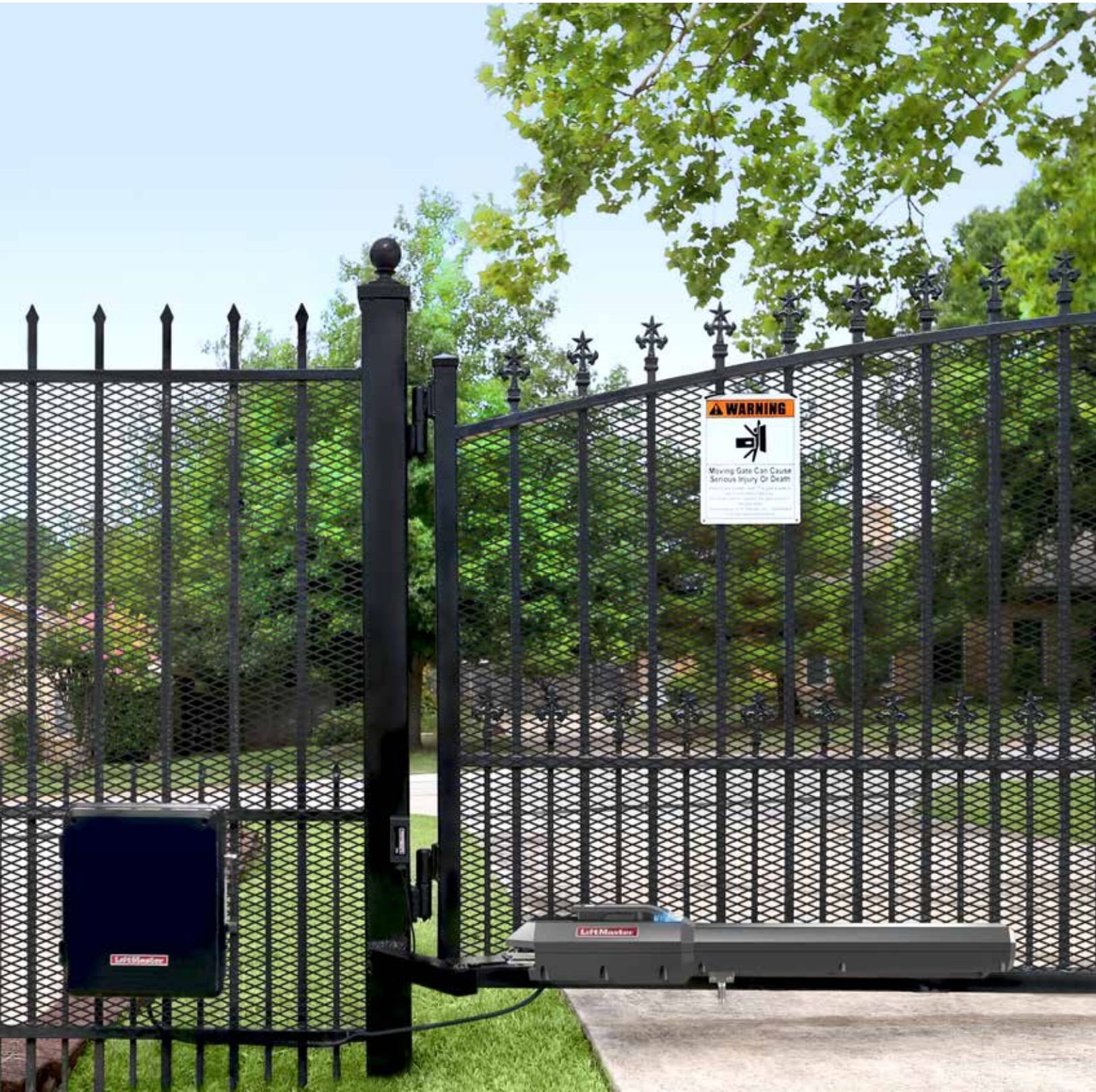

NOTES

A series of 20 horizontal dotted lines for taking notes.

HOW TO ORDER

1 | CHOOSE A MODEL

2 1 0 0
2100

Mounting: Flat Mount – Both Sides
Quantity per Box: 2
Material: All Steel
Finish: P U Z

2 | SELECT A FINISH

2 1 0 0 P

B BLACK **P** PRIME COATED
U UNFINISHED **Z*** ZINC PLATED*

3 | ORDER

To **place your order** visit:
Dealer.LiftMaster.com

Call 800.323.2276

Email Customer.Service@LiftMaster.com

Contact your LiftMaster® Sales Representative

*Electroplated Zinc Coating is tested to ASTM Classification - Protects Against Severe Exposure

TOOLS AND RESOURCES

For additional information on a complete LiftMaster solution, utilize the following tools and resources.

ONLINE TOOLS

- LiftMaster.com/GateHardware
- Dealer.LiftMaster.com
- LiftMasterTraining.com

PLACE YOUR ORDER TODAY.

Dealer.LiftMaster.com | 800.323.2276
[Email Customer.Service@LiftMaster.com](mailto:Customer.Service@LiftMaster.com)
Contact Your LiftMaster Sales Representative

© 2020 LiftMaster All Rights Reserved
300 Windsor Drive, Oak Brook, IL 60523
LiftMaster.com
LMGTENBROUGH 2/20

LiftMaster