



Wi-Fi® LED Garage Door Opener USER'S GUIDE

Models B4603T, B4613T, B4643T, B4655T, B6713T, B6753T, AND B6755T

FOR RESIDENTIAL USE ONLY

- Please read this guide and the enclosed safety materials carefully!
- The door **WILL NOT CLOSE** unless the Protector System® is connected and properly aligned.
- Periodic checks of the garage door opener are required to ensure safe operation.
- This garage door opener is **ONLY** compatible with myQ® and Security+ 2.0® accessories.
- **DO NOT** install on a one-piece door if using devices or features providing unattended close. Unattended devices and features are to be used **ONLY** with sectional doors.
- Attach warning labels to the location indicated on label.

Download the myQ® App to Set Up an Account and Connect

Open and close your door, get alerts and set schedules from anywhere. Connected smart garage door openers also receive software updates to ensure the opener has the latest operational features. See page 1.

Easy step-by-step
interactive 3D instructions
for this product can be found in

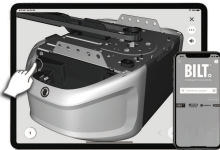

BILT® INTELLIGENT
INSTRUCTIONS

SCAN FOR BILT 3D INSTRUCTIONS



POWERED BY BILT INTELLIGENT INSTRUCTIONS

Download the free BILT App
before assembly

Download the free myQ® App



Monitor and control your garage
from anywhere and get real-time alerts
with peace of mind.



Available on most iOS and Android Devices

To register your garage door opener to receive updates and offers from Chamberlain, visit chamberlain.registria.com or use the icon below:

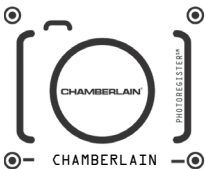

1. **Take a photo** of the camera icon including the points (●).
2. **Send it in** by texting the photo to 71403 (US) **or visit** www.chamberlain.photo (Global).



Contents

Unattended Operation	2
Important Installation Instructions	3
Power	3
Important Safety Instructions	4
Connect With Your Smartphone	5
Test the Wi-Fi® Signal Strength	5
Programming	7
Remote Control	7
Wireless Keyless Entry	7
HomeLink®	7
To Erase the Memory	7
Camera	8
Set Up the Camera	8
Operation	9
To Open the Door Manually	9
Battery Backup	10
Door Controls	10
The Protector System® (Safety Reversing Sensors)	11
Adjustment	12
Introduction	12
Adjustment	13
1 - Program the Travel	13
2 - Automatic Force Set Up	13
3 - Test the Safety Reversal System	14
4 - Test the Protector System®	14
Maintenance	15
Troubleshooting	16
Automatic Garage Door Opener Safety & Maintenance Guide	17
Repair Parts and Accessories	19
Warranty	19

myQ® Serial Number

Write down the following information for future reference:

myQ® Serial Number:

Product Serial Number:

Date of Purchase:

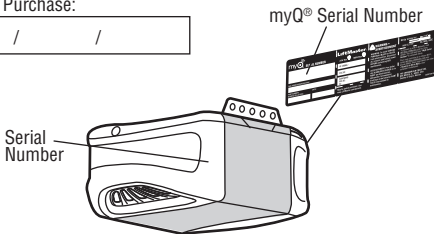
 / /

Safety Symbol and Signal Word Review

This garage door opener has been designed and tested to offer safe service provided it is installed, operated, maintained and tested in strict accordance with the instructions and warnings contained in this manual.

When you see these Safety Symbols and Signal Words on the following pages, they will alert you to the possibility of **serious injury or death** if you do not comply with the warnings that accompany them. The hazard may come from something mechanical or from electric shock. Read the warnings carefully.



WARNING

Mechanical



WARNING

Electrical

When you see this Signal Word on the following pages, it will alert you to the possibility of damage to your garage door and/or the garage door opener if you do not comply with the cautionary statements that accompany it. Read them carefully.



CAUTION



WARNING: This product can expose you to chemicals including lead, which are known to the State of California to cause cancer or birth defects or other reproductive harm. For more information go to www.P65Warnings.ca.gov

Unattended Operation

The Timer-to-Close (TTC) feature, the myQ® App, and myQ® Garage Door and Gate Monitor are examples of unattended close and are to be used **ONLY** with sectional doors. Any device or feature that allows the door to close without being in the line of sight of the door is considered unattended close. The Timer-to-Close (TTC) feature, the myQ® App, and any other myQ® devices are to be used **ONLY** with sectional doors.

Important Installation Instructions

IMPORTANT INSTALLATION INSTRUCTIONS

WARNING

To reduce the risk of SEVERE INJURY or DEATH:

1. READ AND FOLLOW ALL INSTALLATION WARNINGS AND INSTRUCTIONS.
2. Install garage door opener ONLY on properly balanced and lubricated garage door. An improperly balanced door may NOT reverse when required and could result in SEVERE INJURY or DEATH.
3. ALL repairs to cables, spring assemblies and other hardware MUST be made by a trained door systems technician BEFORE installing opener.
4. Disable ALL locks and remove ALL ropes connected to garage door BEFORE installing opener to avoid entanglement.
5. Where possible, install the door opener 7 feet (2.13 m) or more above the floor.
6. Mount the emergency release within reach, but at least 6 feet (1.83 m) above the floor and avoiding contact with vehicles to avoid accidental release.
7. NEVER connect garage door opener to power source until instructed to do so.
8. NEVER wear watches, rings or loose clothing while installing or servicing opener. They could be caught in garage door or opener mechanisms.
9. Install wall-mounted garage door control:
 - within sight of the garage door.
 - out of reach of small children at a minimum height of 5 feet (1.5 m) above floors, landings, steps or any other adjacent walking surface.
 - away from ALL moving parts of the door.
10. Place entrapment warning label on wall next to garage door control.
11. Place manual release/safety reverse test label in plain view on inside of garage door.
12. Upon completion of installation, test safety reversal system. Door MUST reverse on contact with a 1-1/2" (3.8 cm) high object (or a 2x4 laid flat) on the floor.
13. To avoid SERIOUS PERSONAL INJURY or DEATH from electrocution, disconnect ALL electric and battery power BEFORE performing ANY service or maintenance. DO NOT install on a one-piece door if using devices or features providing unattended close. Unattended devices and features are to be used ONLY with sectional doors.

15. SAVE THESE INSTRUCTIONS.

Power

To prevent possible SERIOUS INJURY or DEATH from electrocution or fire:

- Be sure power is NOT connected to the opener, and disconnect power to circuit BEFORE removing cover to establish permanent wiring connection.
- Garage door installation and wiring MUST be in compliance with ALL local electrical and building codes.
- NEVER use an extension cord, 2-wire adapter, or change plug in ANY way to make it fit outlet. Be sure the opener is grounded.

To reduce the risk of electric shock, your garage door opener has a grounding type plug with a third grounding pin. This plug will only fit into a grounding type outlet. If the plug doesn't fit into your outlet, contact a qualified electrician to install the proper outlet.

Option A - Typical Wiring

1. Plug in the garage door opener into a grounded outlet.
2. DO NOT run garage door opener at this time.

Option B - Permanent Wiring

If permanent wiring is required by your local code, refer to the following procedure. To make a permanent connection through the 7/8 inch hole in the top of the motor unit (according to local code):

1. Remove the motor unit cover screws and set the cover aside.
2. Remove the attached 3-prong cord.
3. Connect the black (line) wire to the screw on the brass terminal; the white (neutral) wire to the screw on the silver terminal; and the ground wire to the green ground screw. **The opener must be grounded.**
4. Reinstall the cover.

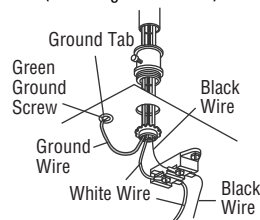

Important Safety Instructions

IMPORTANT SAFETY INSTRUCTIONS



To reduce the risk of SEVERE INJURY or DEATH:

1. READ AND FOLLOW ALL WARNINGS AND INSTRUCTIONS.
2. ALWAYS keep remote controls out of reach of children. NEVER permit children to operate or play with garage door control push buttons or remote controls.
3. ONLY activate garage door when it can be seen clearly, it is properly adjusted, and there are no obstructions to door travel.
4. ALWAYS keep garage door in sight and away from people and objects until completely closed. NO ONE SHOULD CROSS THE PATH OF THE MOVING DOOR.
5. NO ONE SHOULD GO UNDER A STOPPED, PARTIALLY OPENED DOOR.
6. If possible, use emergency release handle to disengage trolley ONLY when garage door is CLOSED. Use caution when using this release with the door open. Weak or broken springs or unbalanced door could result in an open door falling rapidly and/or unexpectedly and increasing the risk of SEVERE INJURY or DEATH.
7. NEVER use emergency release handle unless garage doorway is clear of persons and obstructions.
8. NEVER use handle to pull garage door open or closed. If rope knot becomes untied, you could fall.
9. After ANY adjustments are made, the safety reversal system MUST be tested.
10. ALWAYS KEEP GARAGE DOOR PROPERLY BALANCED. An improperly balanced door may NOT reverse when required and could result in SEVERE INJURY or DEATH.
11. ALL repairs to cables, spring assemblies and other hardware, ALL of which are under EXTREME tension, MUST be made by a trained door systems technician.
12. To avoid interference with the proper operation of the garage door opener when using a welder in the garage, unplug garage door opener before operating welder.
13. To avoid SERIOUS PERSONAL INJURY or DEATH from electrocution, disconnect ALL electric and battery power BEFORE performing ANY service or maintenance.
14. This operator system is equipped with an unattended operation feature. The door could move unexpectedly. NO ONE SHOULD CROSS THE PATH OF THE MOVING DOOR.
15. DO NOT install on a one-piece door if using devices or features providing unattended close. Unattended devices and features are to be used ONLY with sectional doors.
16. **SAVE THESE INSTRUCTIONS.**

NOTICE: This device complies with part 15 of the FCC rules and Innovation, Science and Economic Development Canada license-exempt RSSs. Operation is subject to the following two conditions: (1) this device may not cause harmful interference, and (2) this device must accept any interference received, including interference that may cause undesired operation.

Any changes or modifications not expressly approved by the party responsible for compliance could void the user's authority to operate the equipment.

This device must be installed to ensure a minimum 20 cm (8 in.) distance is maintained between users/bystanders and device.

This device has been tested and found to comply with the limits for a Class B digital device, pursuant to part 15 of the FCC rules and Industry Canada ICES standard. These limits are designed to provide reasonable protection against harmful interference in a residential installation. This equipment generates, uses and can radiate radio frequency energy and, if not installed and used in accordance with the instructions, may cause harmful interference to radio communications. However, there is no guarantee that interference will not occur in a particular installation. If this equipment does cause harmful interference to radio or television reception, which can be determined by turning the equipment off and on, the user is encouraged to try to correct the interference by one or more of the following measures:

- Reorient or relocate the receiving antenna.
- Increase the separation between the equipment and receiver.
- Connect the equipment into an outlet on a circuit different from that to which the receiver is connected.
- Consult the dealer or an experienced radio/TV technician for help.

Connect With Your Smartphone

IMPORTANT: Set up a myQ® account and connect your garage door opener to the Wi-Fi® network using the myQ App before finalizing installation

You must set up a myQ® account and connect the garage door opener to Wi-Fi® in order for it to be installed successfully.

You will need:

- Wi-Fi® enabled smartphone, tablet or laptop
- Broadband Internet Connection
- Wi-Fi® signal in the garage (**2.4 GHz, 802.11b/g/n required**)
- Password for your home network (router's main account, not guest network)

Test the Wi-Fi® Signal Strength

Make sure your mobile device is connected to your Wi-Fi® network. Hold your mobile device in the place where your garage door opener is installed and check the Wi-Fi signal strength.

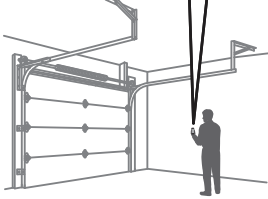

Check Signal Strength. If you see:



Wi-Fi signal is strong.
The garage door opener will connect to your Wi-Fi network.



Wi-Fi signal is weak.
The garage door opener may connect to your Wi-Fi network. If not, try one of the options below to improve the Wi-Fi signal:



No Wi-Fi signal.
The garage door opener will not be able to connect to your Wi-Fi network. Try one of the options below to improve the Wi-Fi signal:

- Move your router closer to the garage door opener to minimize interference from walls and other objects
- Buy a Wi-Fi range extender

For compatible router specifications and help, visit support.chamberlaingroup.com.

Connect With Your Smartphone

Download the myQ® App to Set Up an Account and Connect

Open and close your door, get alerts and set schedules from anywhere. Connected smart garage door openers also receive software updates to ensure the opener has the latest operational features.

The garage door opener must run through a complete cycle before it will activate Wi-Fi® programming.

1. Download the myQ® App.
2. Set up an account and connect.

If you already have the myQ® App installed:

1. Check that your mobile device has the latest software.
2. Download the latest version of the myQ® App.



For more information on connecting your garage door opener, visit support.chamberlaingroup.com.

Wi-Fi Status	
LED	Definition
Blue	Off - Wi-Fi® is not turned on. Blinking - Garage door opener is in Wi-Fi® learn mode. Solid - Mobile device connected to the garage door opener.
Blue and Green	Blinking - Attempting to connect to router.
Green	Blinking - Attempting to connect to the Internet server. Solid - Wi-Fi® has been set up and garage door opener is connected to the Internet.

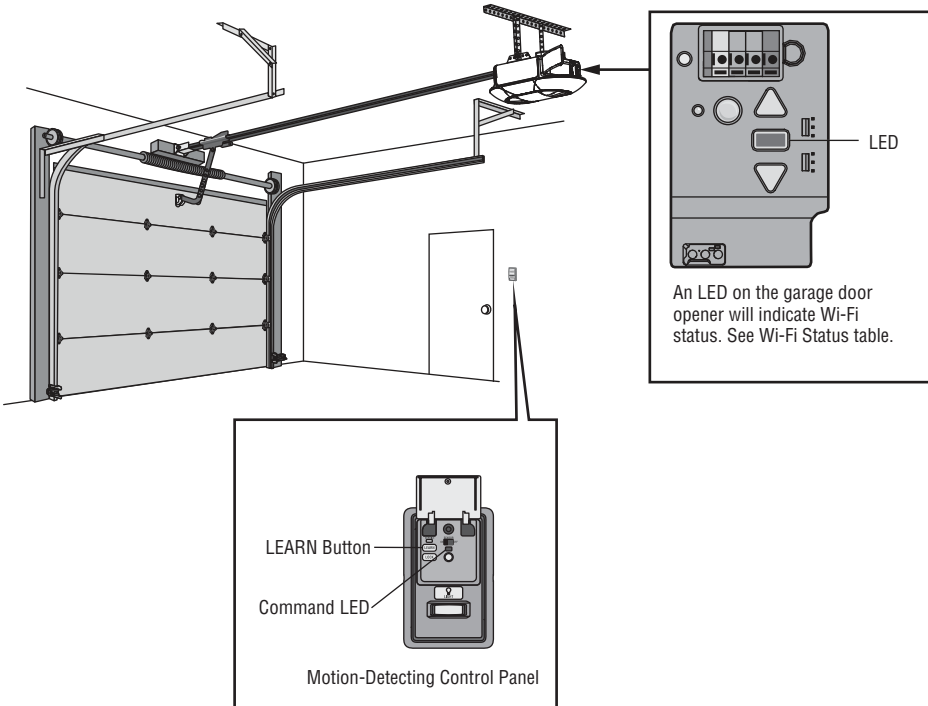

Google Play and the Google Play logo are trademarks of Google LLC.
App Store and the Apple and App Store logos are trademarks of Apple Inc.

Programming

Remote Control

Pre-programmed remote control included, no need to program the remote.

To add or reprogram a remote control, follow the instructions below.

Program Using the Garage Door Opener LEARN Button

1. Press and release the LEARN Button on the garage door opener.
2. Press and hold the button on the remote control that you wish to use. Release the button when the garage door opener lights blink or two clicks are heard.

Note: Remote may vary.

Program Using the Multi-Function or Motion-Detecting Control Panel

1. Press the LEARN button on the door control to enter programming mode.
2. Press the LEARN button again, the command LED will flash once.
3. Press the button on the remote control that you wish to operate your garage door.

Wireless Keyless Entry

Refer to the instructions provided with your keyless entry OR go to Chamberlain.com to download instructions.

HomeLink®

If your vehicle is equipped with HomeLink®, a Compatibility Bridge™ (not included) may be necessary for certain vehicles. Visit bridge.chamberlain.com to find out if a Bridge is needed.

To Erase the Memory

Erase ALL Remote Controls and Keyless Entries

Press and hold the LEARN button until the LED goes out (approximately 6 seconds).

All remote controls and keyless entries are now erased.

Erase ALL Devices (Including myQ® enabled accessories)

1. Press and hold the LEARN button until the LED goes out (approximately 6 seconds).
2. Immediately press and hold the LEARN button until the LED goes out. All codes are now erased.

Erase the Wi-Fi Network from the Garage Door Opener

Press and hold the adjustment button until 3 beeps are heard (approximately 6 seconds).

Erase the Camera Settings - Models B4655T, B6713T, B6753T and B6755T

Press and hold the reset button on the side of the camera for 10 seconds. The LED light will turn off, then flash red.

You will need to set up your camera again after resetting it.

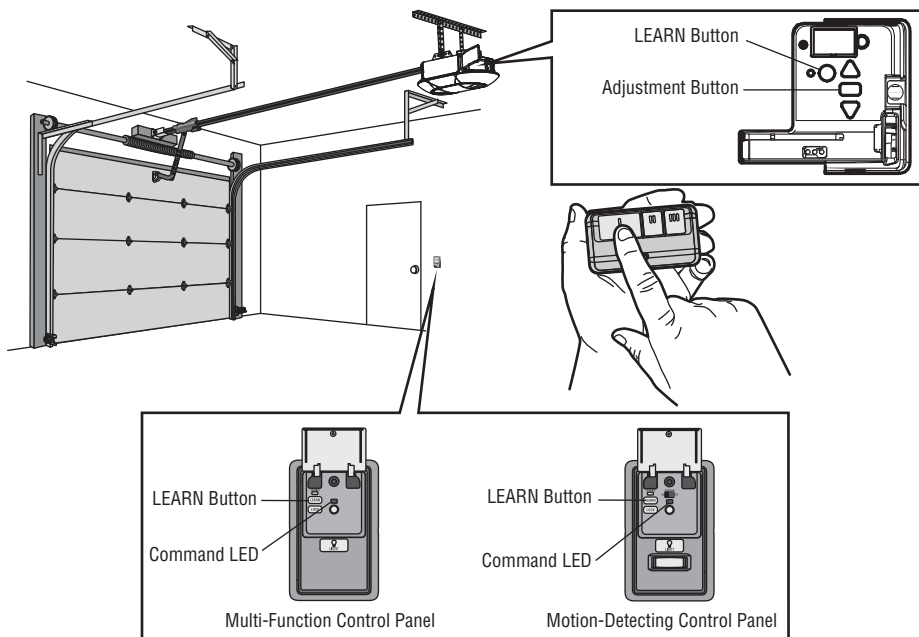

Camera

Set Up the Camera

Models B4655T, B6713T, B6753T, AND B6755T ONLY

1. Download the myQ® app and setup your account if you haven't already, see page 1.
2. Follow the instructions in the app to setup and use the camera.

The camera powers up when it is opened and powers down when closed. An LED on the camera indicates the status. See the camera status table.

For more information on using the camera, visit support.chamberlaingroup.com.

NOTES:

myQ® App control and camera WILL NOT work if the garage door opener is operating on battery power.
To erase the camera settings from the opener, see 1.

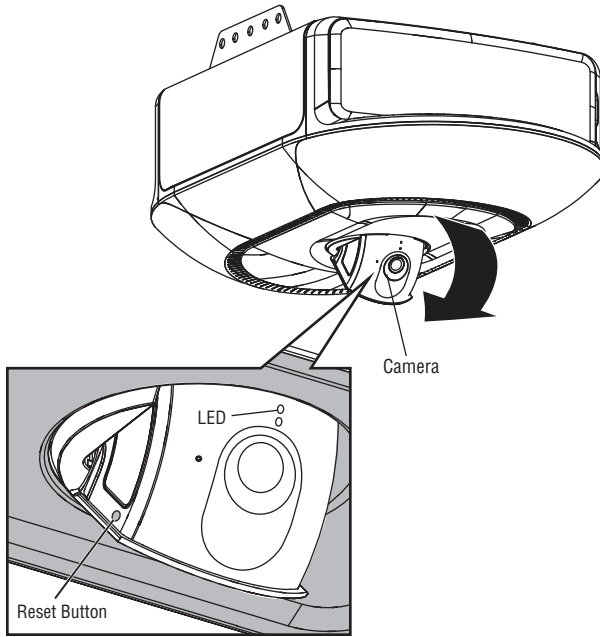

Camera Status	
LED	Definition
Flashing Blue	Camera is attempting to connect to the mobile device.
Solid Blue	Camera is connected to the mobile device.
Flashing Blue and Green	Camera is attempting to connect to the router.
Flashing Green	Camera is connected to the router and attempting to connect to myQ® server.
Solid Green	Camera is connected and working normally.
Solid White	Camera is powering up.
Flashing Red	Camera is overheating.
Flashing Purple	Camera firmware is updating.

Operation

WARNING

To prevent possible **SERIOUS INJURY** or **DEATH** from a falling garage door:

- If possible, use emergency release handle to disengage trolley **ONLY** when garage door is **CLOSED**. Weak or broken springs or unbalanced door could result in an open door falling rapidly and/or unexpectedly.
- **NEVER** use emergency release handle unless garage doorway is clear of persons and obstructions.
- **NEVER** use handle to pull door open or closed. If rope knot becomes untied, you could fall.

To Open the Door Manually

NOTE: Disengage any door locks before proceeding.

1. The door should be fully closed if possible.
2. Pull down on the emergency release handle.

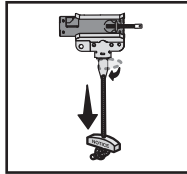

Lockout Feature

1. Pull the emergency release handle down and back. The door can then be raised and lowered manually as often as necessary.
2. To disengage the lockout feature, pull the handle straight down.

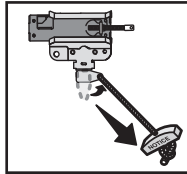

The trolley will reconnect on the next time the opener is activated.

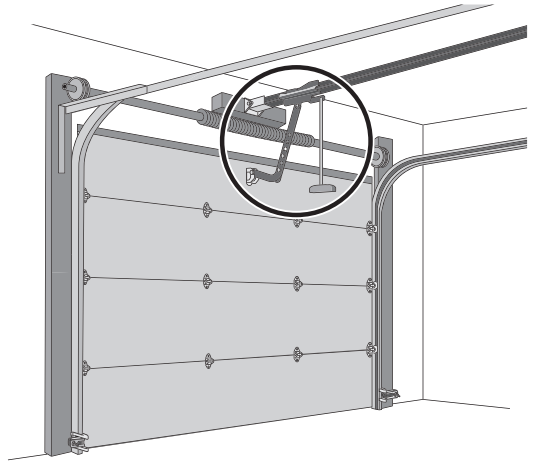

Operation

Battery Backup

Models B6713T, B6753T, and B6755T

The battery backup allows access in and out of your garage when the power is out. When the garage door opener is operating on battery power, the garage door opener will run slower and the lights, Timer-to-Close, and remote close features (myQ® App) are disabled. In battery backup mode, the Automatic Garage Door Lock will unlock when the garage door is opened, and will remain disabled until power is restored. During a power outage the battery supplies power for up to 24 hours of operation. For maximum battery life and prevent damage, disconnect the battery when the garage door opener is unplugged for an extended period of time.

Green battery status LED: All systems are normal.

- A solid green LED light indicates the battery is fully charged.
- A flashing green LED indicates the battery is being charged.

Orange battery status LED: The garage door opener has lost power and is in battery backup mode.

- Solid orange LED while the motor is on, indicates the garage door opener is operating on battery power.
- A flashing orange LED while the motor is on, indicates the battery is low.

Red battery status LED: The garage door opener's 12V battery needs to be replaced.

- A solid red LED indicates the 12V battery will no longer hold a charge.

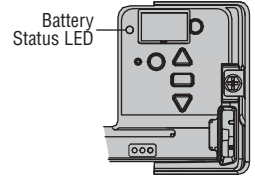

Door Controls

Multi-Function Control Panel

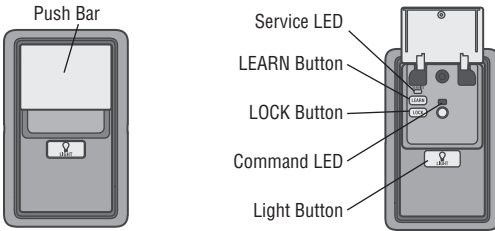

Motion-Detecting Control Panel

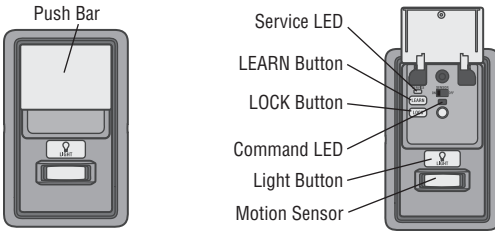

Operation

The Protector System® (Safety Reversing Sensors)



WARNING

Be sure power is NOT connected to the garage door opener BEFORE installing the safety reversing sensor.
To prevent SERIOUS INJURY or DEATH from closing garage door:

- Correctly connect and align the safety reversing sensor. This required safety device MUST NOT be disabled.
- Install the safety reversing sensor so beam is NO HIGHER than 6" (15 cm) above garage floor.

The door will not close if the sensors have not been installed and aligned correctly.

When the light beam is obstructed or misaligned while the door is closing, the door will reverse. If the door is already open, it will not close.

The sensors can be aligned by loosening the wing nuts, aligning the sensors, and tightening the wing nuts. Check to make sure the LEDs in both sensors are glowing steadily. The LEDs in both sensors will glow steadily if they are aligned and wired correctly.

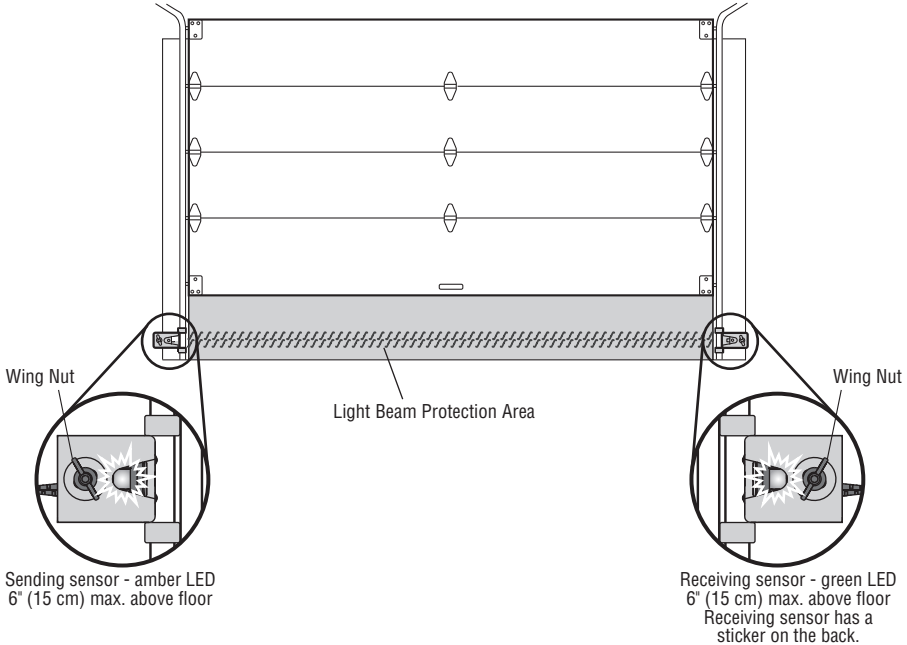

If either of the sensor LEDs are off, there is no power to the sensor:

1. Check that you have power to the garage door opener.
2. Check the sensor wire is not shorted or broken.
3. Check that the sensors are wired correctly; white wires to white terminal and white/black wires to grey terminal.

If the green receiving sensor LED is blinking, the sensors are obstructed or misaligned:

1. Check for obstructions in the sensor light beam.
2. Align the sensors.
3. If the receiving sensor (green LED) faces direct sunlight, switch the sensors to opposite sides of the door to assure proper operation.

Adjustment

Introduction

WARNING

Without a properly installed safety reversal system, persons (particularly small children) could be **SERIOUSLY INJURED** or **KILLED** by a closing garage door.

- Incorrect adjustment of garage door travel limits will interfere with proper operation of safety reversal system.
- After ANY adjustments are made, the safety reversal system **MUST** be tested. Door **MUST** reverse on contact with 1-1/2" (3.8 cm) high object (or 2x4 laid flat) on floor.

CAUTION

To prevent damage to vehicles, be sure fully open door provides adequate clearance.

Your garage door opener is designed with electronic controls to make setup and adjustments easy. The adjustments allow you to program where the door will stop in the open (UP) and close (DOWN) position. The electronic controls sense the amount of force required to open and close the door. The force is adjusted automatically when you program the travel. While programming the travel, the UP and DOWN buttons can be used to move the door as needed. During the Automatic Force Setup, the door will automatically open and close.

NOTE: *If anything interferes with the door's upward travel it will stop. If anything interferes with the door's downward travel, it will reverse.*

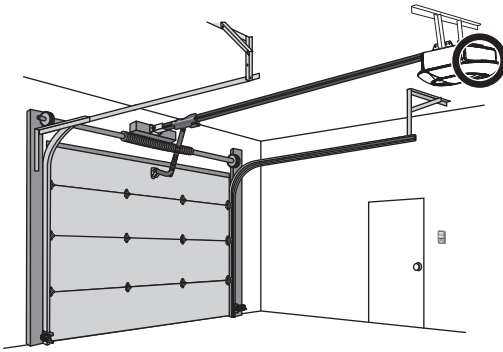

Programming Buttons

The programming buttons are located on the side panel of the garage door opener and are used to program the travel. While programming, the UP and DOWN buttons can be used to move the door as needed.

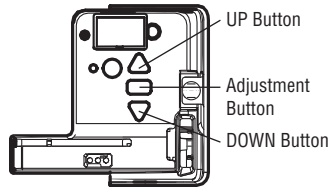

Adjustment

1 - Program the Travel

WARNING

Without a properly installed safety reversal system, persons (particularly small children) could be **SERIOUSLY INJURED** or **KILLED** by a closing garage door.

- Incorrect adjustment of garage door travel limits will interfere with proper operation of safety reversal system.
- After ANY adjustments are made, the safety reversal system **MUST** be tested. Door **MUST** reverse on contact with 1-1/2" (3.8 cm) high object (or 2x4 laid flat) on floor.

Note: While programming the travel, the UP and DOWN buttons can be used to move the door as needed. During the Automatic Force Setup, the door will automatically open and close.

1 Press and hold the Adjustment Button until the UP Button begins to flash and/or a beep is heard. The Safety Reversing Sensors will be disconnected during the Program the Travel process.

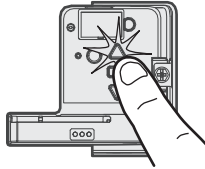

2 Press and hold the UP Button until the door is in the desired UP position.

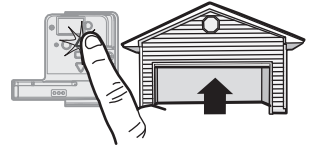

3 Once the door is in the desired UP position press and release the Adjustment Button. The garage door opener lights will flash twice and the DOWN Button will begin to flash.

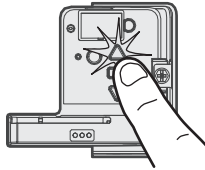

4 Press and hold the DOWN button until the door is in the desired DOWN position.



5 Once the door is in the desired DOWN position press and release the Adjustment Button. The garage door opener lights will flash twice. Program the Travel is now complete. If the garage door opener lights flash 5 times, then programming has timed out and the Travel Limits have not been set. Please restart the Program the Travel process.

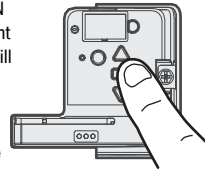

2 - Automatic Force Set Up

Once both the up and down positions have been manually set, the Safety Reversing Sensors will reconnect and become operational. Then, the opener will enter a force-sensing operation by automatically moving the door open and close. The garage door opener will sound an audible and visual alert before automatically opening and closing the door. The garage door opener will beep three times, confirming that the Automatic Force Setup completed successfully. Adjustment is complete.

If you hear one long beep after the door attempts to move, then the Automatic Force Set Up has not completed successfully. Please start over at step 1 of Program the Travel.



Adjustment

3 - Test the Safety Reversal System

WARNING

Without a properly installed safety reversal system, persons (particularly small children) could be **SERIOUSLY INJURED** or **KILLED** by a closing garage door.

- Safety reversal system **MUST** be tested every month.
- After **ANY** adjustments are made, the safety reversal system **MUST** be tested. Door **MUST** reverse on contact with 1-1/2" (3.8 cm) high object (or 2x4 laid flat) on the floor.

1 With the door fully open, place a 1-1/2 inch (3.8 cm) board (or a 2x4 laid flat) on the floor, centered under the garage door.



2 Press the remote control push button to close the door. The door **MUST** reverse when it makes contact with the board.

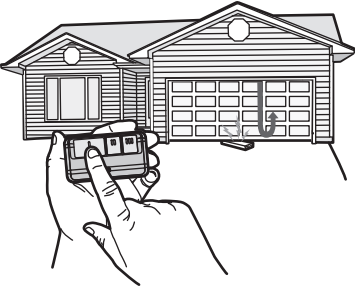

If the door stops but does not reverse:

1. Repeat Program the Travel (see Adjustment Step 1);
2. Repeat the Safety Reversal test.

If the test continues to fail, call a trained door systems technician.

4 - Test the Protector System®

WARNING

Without a properly installed safety reversing sensor, persons (particularly small children) could be **SERIOUSLY INJURED** or **KILLED** by a closing garage door.

1 Open the door. Place an obstruction in the path of the door.



2 Press the remote control push button to close the door. The door will not move more than an inch (2.5 cm).

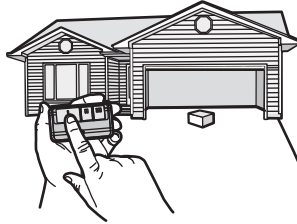

The garage door opener will not close from a remote control if the LED in either safety reversing sensor is off (alerting you to the fact that the sensor is misaligned or obstructed).

If the garage door opener closes the door when the safety reversing sensor is obstructed (and the sensors are no more than 6 inches [15 cm] above the floor), call for a trained door systems technician.

Maintenance

Every Month

- Manually operate door. If it is unbalanced or binding, call a trained door systems technician.
- Check to be sure door opens and closes fully. Adjust if necessary, page 13.
- Test the safety reversal system. Adjust if necessary, page 1.

Every Year

- Oil door rollers, bearings and hinges. The garage door opener does not require additional lubrication. Do not grease the door tracks.
- (If applicable) Test the battery backup and consider replacing the battery to ensure the garage door opener will operate during an electrical power outage.
 1. Unplug the garage door opener from AC power. The battery status LED will glow solid orange (opener is operating on battery power) or will flash (low battery power).
 2. Open and close the door using the remote control or door control.
 3. In battery backup mode, the Automatic Garage Door Lock will unlock when the garage door is opened, and will remain disabled until power is restored.
 4. Plug in the garage door opener. Verify the battery status LED is flashing green (battery is charging).

The Remote Control Battery

WARNING

To prevent possible **SERIOUS INJURY** or **DEATH**:

- NEVER allow small children near batteries.
- If battery is swallowed, immediately notify doctor.

To reduce risk of fire, explosion or chemical burn:

- Replace **ONLY** with 3V CR2032 coin batteries.
- **DO NOT** recharge, disassemble, heat above 212°F (100°C) or incinerate.

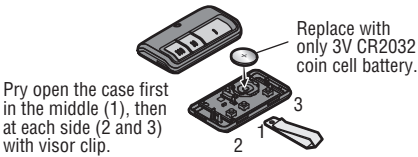

Troubleshooting

Below are basic troubleshooting tips, for additional help and support videos visit support.chamberlain.com or contact your installing dealer.

My garage door opener will not close:

Check to make sure the LEDs in both sensors are glowing steadily. The LEDs in both sensors will glow steadily if they are aligned and wired correctly. See page 1.

My vehicle's Homelink® is not programming to my garage door opener:

Depending on the make, model, and year of your vehicle an external adapter may be required. Visit www.homelink.com for additional information.

My garage door opener beeps:

The garage door opener can beep for several reasons:

- The opener senses an obstruction while traveling.
- Garage door opener has been activated through a device or feature such as Timer-to-Close, garage door monitor or Chamberlain Internet Gateway.

My neighbor's remote control opens my garage door:

Erase the memory from your garage door opener and reprogram the remote control(s).

The garage door moves 6-8", stops or reverses:

- Manually open and close the garage door. Garage door may be binding or there may be an obstruction. If the door is binding, call a trained door systems technician.
- Possible travel module failure.

My remote control will not activate the garage door:

Verify the lock feature is not activated on the door control or reprogram the remote control.

The wall-mounted door control will not function:

The wires for the door control are shorted or the door control is faulty.

Garage door opener hums for 1-2 seconds with no movement and 5 flashes and 5 beeps occur:

Manually open and close the garage door. Garage door may be binding or there may be an obstruction. If the door is binding, call a trained door systems technician.

Cannot connect garage door opener to home Wi-Fi network:

Ensure the myQ® Serial number was entered correctly and try again. The myQ® characters are between A-F and 0-9 only.

My camera won't connect to the router:

- Move your router closer to the garage door opener to minimize interference from walls and other objects.
- Buy a Wi-Fi range extender.
- For issues with the camera, press and hold the reset button on the camera for 10 seconds. Then, follow the myQ® app instructions to set up the camera.

For complete manuals or available parts and accessories, visit support.chamberlaingroup.com.

Automatic Garage Door Opener Safety & Maintenance Guide

Garage Door Opener Safety – An Automatic Decision

A garage door is the largest moving object in the home. An improperly adjusted garage door and opener can exert deadly force when the door closes – which could lead to entrapment of children or adults and subsequent injury or death.

Proper installation, operation, maintenance, and testing of the garage door and automatic opener are necessary to provide a safe, trouble-free system. Careless operation or allowing children to play with or use garage door opener controls are also dangerous situations that can lead to tragic results. A few simple precautions can protect your family and friends from potential harm. Please review the safety and maintenance tips in this guide carefully and keep it for reference. Check the operation of your garage door and opener to ensure they function in a safe and trouble-free manner. Be sure to read all Important Safety Information found in your garage door opener's manual as it provides more details and safety considerations than can be supplied with this guide.

Garage Door Openers are Not Toys

Discuss garage door and opener safety with your children. Explain the danger of being trapped under the door.



Stay away from a moving door.



Keep transmitters and remote controls out of reach of children. Do not let children play with or use transmitters or other remote control devices.



The wall-mounted push button should be out of reach of children, at least 5 feet from the nearest standing surface and away from all moving parts. Mount and use the button where you can clearly see the closing garage door.



Keep the door in sight until it completely closes when using the wall-mounted push button or transmitter.

Routine Maintenance Can Prevent Tragedies

Make monthly inspection and testing of your garage door and opener system a part of your regular routine. Review your owner's manual for both the door and door opener. If you don't have the owner's manuals, contact the manufacturer(s) and request a copy for your specific model(s). Look for the opener model number on the back of the power unit.

! WARNING – Springs are under high tension. Only qualified individuals should adjust them.



Visually check the door and installation:

- Starting with the door in the closed position, use the manual disconnect on the opener to disconnect the door.
- Look for signs of wear or damage on hinges, rollers, springs, and door panels.
- These parts may require periodic lubrication. Check the owner's manual for suggested maintenance.
- If any signs of damage are evident, contact a trained door systems technician for assistance.
- Verify the photoeye height is no higher than 6" from the garage floor.

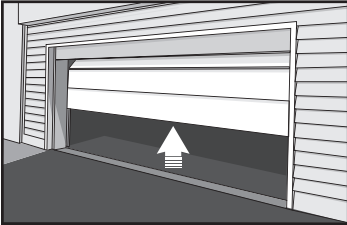

Test the door for proper operation:

- Open and close the door manually using handles or suitable gripping points.
- The door should move freely and without difficulty.
- **The door should balance and stay partially open 3-4 feet above the floor.**
- If you detect any signs of improper operation, contact a trained door systems technician for assistance.

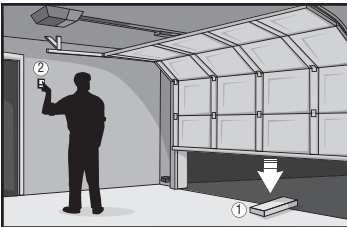

Test the opener safety features:

- Reconnect the opener to the door using the manual disconnect and open the door.
- Place a 2x4 board flat in the path of the door (1) and try to close it (2). The door should stop when it comes in contact with the 2x4 and then reverse direction.
- Block the photoelectric sensor by waving an object in front of the sensor and attempt to close the door. The door should not close unless the wall-mounted push button is manually held during operation.
- If the opener does not perform as described, contact a trained door systems technician for assistance.



Repair Parts and Accessories

To see repair parts or accessories for your garage door opener, identify the model number on the end panel of the opener and visit support.chamberlaingroup.com to download or print the installation manual.

Warranty

CHAMBERLAIN® LIMITED WARRANTY

The Chamberlain Group LLC® ("Seller") warrants to the first retail purchaser of this product, for the residence in which this product is originally installed, that it is free from defects in materials and/or workmanship for a specific period of time as defined below (the "Warranty Period"). The warranty period commences from the date of purchase.

WARRANTY PERIOD							
Models	Parts	Motor	Accessories	Belt	Battery Backup	Integrated LED	Camera
B4603T	5 years	Lifetime	1 year	Lifetime	-	5 years	-
B4613T	5 years	Lifetime	1 year	Lifetime	1 year	5 years	-
B4643T	5 years	Lifetime	1 year	Lifetime	1 year	5 years	1 year
B4655T	5 years	Lifetime	1 year	Lifetime	1 year	5 years	1 year
B6753T	5 years	Lifetime	1 year	Lifetime	1 year	5 years	1 year
B6755T	5 years	Lifetime	1 year	Lifetime	1 year	5 years	1 year

The proper operation of this product is dependent on your compliance with the instructions regarding installation, operation, and maintenance and testing. Failure to comply strictly with those instructions will void this limited warranty in its entirety.

If, during the limited warranty period, this product appears to contain a defect covered by this limited warranty, visit chamberlain.com, before dismantling this product. You will be advised of disassembly and shipping instructions. Then send the product or component, pre-paid and insured, as directed to our service center for warranty repair. Please include a brief description of the problem and a dated proof-of-purchase receipt with any product returned for warranty repair. Products returned to Seller for warranty repair, which upon receipt by Seller are confirmed to be defective and covered by this limited warranty, will be repaired or replaced (at Seller's sole option) at no cost to you and returned pre-paid. Defective parts will be repaired or replaced with new or factory-rebuilt parts at Seller's sole option. [You are responsible for any costs incurred in removing and/or reinstalling the product or any component].

ALL IMPLIED WARRANTIES FOR THE PRODUCT, INCLUDING BUT NOT LIMITED TO ANY IMPLIED WARRANTIES OF MERCHANTABILITY AND FITNESS FOR A PARTICULAR PURPOSE, ARE LIMITED IN DURATION TO THE APPLICABLE LIMITED WARRANTY PERIOD SET FORTH ABOVE FOR THE RELATED COMPONENT(S), AND NO IMPLIED WARRANTIES WILL EXIST OR APPLY AFTER SUCH PERIOD. Some States and Provinces do not allow limitations on how long an implied warranty lasts, so the above limitation may not apply to you. THIS LIMITED WARRANTY DOES NOT COVER NON-DEFECT DAMAGE, DAMAGE CAUSED BY IMPROPER INSTALLATION, OPERATION OR CARE (INCLUDING, BUT NOT LIMITED TO ABUSE, MISUSE, FAILURE TO PROVIDE REASONABLE AND NECESSARY MAINTENANCE, UNAUTHORIZED REPAIRS OR ANY ALTERATIONS TO THIS PRODUCT), LABOR CHARGES FOR REINSTALLING A REPAIRED OR REPLACED UNIT, REPLACEMENT OF CONSUMABLE ITEMS (E.G., BATTERIES IN REMOTE CONTROL TRANSMITTERS), OR UNITS INSTALLED FOR NON-RESIDENTIAL USE. THIS LIMITED WARRANTY DOES NOT COVER ANY PROBLEMS WITH, OR RELATING TO, THE GARAGE DOOR OR GARAGE DOOR HARDWARE, INCLUDING BUT NOT LIMITED TO THE DOOR SPRINGS, DOOR ROLLERS, DOOR ALIGNMENT OR HINGES. THIS LIMITED WARRANTY ALSO DOES NOT COVER ANY PROBLEMS CAUSED BY INTERFERENCE. UNDER NO CIRCUMSTANCES SHALL SELLER BE LIABLE FOR CONSEQUENTIAL, INCIDENTAL OR SPECIAL DAMAGES ARISING IN CONNECTION WITH USE, OR INABILITY TO USE, THIS PRODUCT. IN NO EVENT SHALL SELLER'S LIABILITY FOR BREACH OF WARRANTY, BREACH OF CONTRACT, NEGLIGENCE OR STRICT LIABILITY EXCEED THE COST OF THE PRODUCT COVERED HEREBY. NO PERSON IS AUTHORIZED TO ASSUME FOR US ANY OTHER LIABILITY IN CONNECTION WITH THE SALE OF THIS PRODUCT.

Some states and provinces do not allow the exclusion or limitation of consequential, incidental or special damages, so the above limitation or exclusion may not apply to you. This limited warranty gives you specific legal rights, and you may also have other rights, which vary from state to state and province to province.

